













EN Appropriate for the listed vehicles **FR** Les barres de toit ne doivent pas être utilisées sur des véhicules autres que spécifiés **ES** Válido para la lista adjunta de vehículos **DE** Passend für die gelisteten Fahrzeuge **IT** Appropriare per veicolo **NL** Geschikt voor voertuig **PT** Apropriado aos seguintes veículos **PL** Pasuje do samochodów **HU** Megfelelő gépjármű **RU** Подходит для автомобилей **RO** Convenabil pentru vehicul **SK** Vhodné pre vozidlo **CS** Vhodné do vozidel **SV** Takracket endast avsett för angivna fordon **BG** Релсите за багажник на покрива не трябва да се използват при автомобили, различни от посочените **TR** Tavan barları belirtilen araçların dışındaki araçlarda kullanılmamalıdır **UK** Рейлінги не можна встановлювати на автомобілі, яких немає у списку **EL** Για το οχήμα **DA** Egnet til køretøjer

   				   				   			
VOLKSWAGEN				MULTIVAN (T5)				4 03 → 15 150			
CALIFORNIA (T5)				MULTIVAN (T6)				4 15 → 150			
CALIFORNIA (T6)				SHUTTLE (T5)				4 03 → 15 150			
CARAVELLE (T5)				SHUTTLE (T6)				4 15 → 150			
CARAVELLE (T6)				TRANSPORTER (T5)				4 03 → 15 150			
				TRANSPORTER (T6)				4 15 → 150			

Mont Blanc®

roof bars, boxes, bike carriers, etc.

PRO RACK MEDIUM N°316



S 109

a x 1 

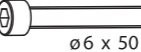
b x 4  ø6 x 50

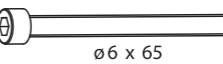
c x 2  ø6 x 65

d x 6  ø6,3

e x 6  ø6

h x 2
(P047)

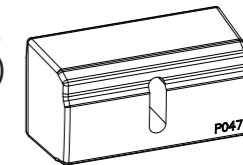

i x 4
(P048)

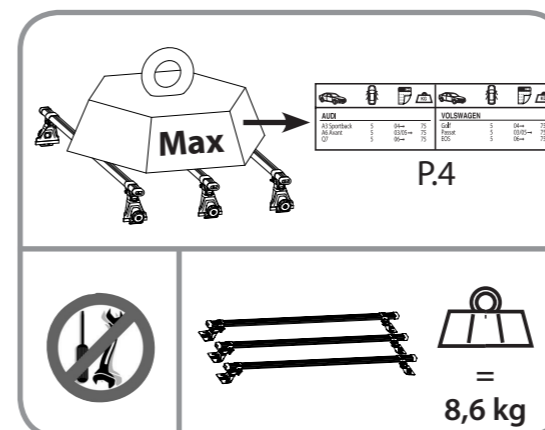
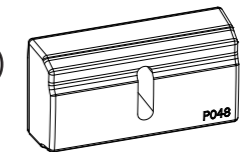

EN Keep these instructions for future use.
FR Garder cette notice pour les utilisations futures.
ES Guardar este manual para futuras utilizaciones.
DE Die Anleitung zur späteren Benutzung aufbewahren.
IT Conservare queste istruzioni per ogni ulteriore consultazione.
NL Bewaar deze gebruiksaanwijzing voor toekomstige raadpleging.
PT Guardar este manual para as utilizações futuras.
PL Zachować instrukcję w przypadku użytkowania w przyszłości.
HU Őrizze meg ezt a használati utasítást későbbi felhasználás céljából.
RO Păstrați instrucțiunile pentru consultarea lor ulterioară.
SK Tento návod si uchovajte pre ďalšie použitie.
CS Uchovajte návod pro pozdější použití.
SV Behåll denna information för framtida bruk.
BG Запазете това упътване за бъдещи справки.
TR Bu kılavuzu daha sonraki kullanımlar için saklayınız.
UK Збережіть цю інструкцію для використання у подальшому.
EL Φυλάξτε αυτό το εγχειρίδιο οδηγιών για μελλοντικές χρήσεις.
DA Gem denne vejledning til senere brug.

Réf. imp. : 058284/A17-1



Mont Blanc France

24-30 rue Claude Bernard - C.S. 61768
 35417 Saint Malo Cédex - France
 After Sales : +33 (0)2 99 21 12 72
 Office : +33 (0)2 99 21 12 70
 Fax : +33 (0)2 99 21 12 71

www.montblancgroup.com



Pour en savoir plus :
www.quefairedemesdechets.fr

EN Fitting on vehicles **FR** Montage sur véhicule **ES** Colocación en vehículos **DE** Montagen auf Fahrzeugen **IT** Montaggio su veicoli **NL** Montage op voertuigen **PT** Montagens em veículos **PL** Montowanie na pojazdach **HU** Felszerelés gépjárműre **RU** Монтаж на автомобиль **RO** Montaj pe vehicul **SK** Upevnenie na vozidlá **CS** Montáž na vozidlo **SV** Montering på fordon **BG** Монтаж върху превозни средства **TR** Araçlara Montaj **UK** встановлення на автомобіль **EL** Τοποθέτηση στο όχημα **DA** Montage på køretøjer

