

901-90x

Lv7 2018-r1

Modelo-model:

Modul-Rack Safari A

Lote-Lot-Lot-Lot:



Peso-Weight-Poids-Gewicht:

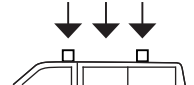
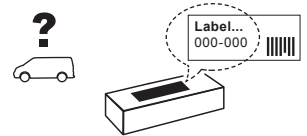

CEE - EEC type approval:



26 R- 04 3024



CITY CRASH (M)

CRUZBER SA
ES-A14018311
P.I. Las Salinas II
14960 - Rute - Spain
www.cruzber.com

- | | |
|--|--------------------|
| (E) Instrucción de montaje
¡Leer primero! | Portaequipajes |
| (GB) Assembly instructions
Read first! | Roof racks |
| (F) Instruction de montage
Lire en premier! | Galleries |
| (D) Montageanleitung
Zuerst lesen! | Dachgepäckträger |
| (PT) Instruções de montagem
Ler primeiro! | Porta bagagens |
| (PL) Instrukcja montażu
Najpierw przeczytaj! | Bagażnik dachowy |
| (CZ) Montážní návod
Čtěte pozorně! | Strešní nosiče |
| (HU) Szerelési Utasítás
Először olvasd el! | Csomagtartó |
| (RO) Instrucțiuni de montaj
Întai citiți! | Krovni nosač |
| (HR) Detaljne upute
Prvo procitati! | Portbagaj |
| (GR) Διαβάστε προσεκτικά τις
Οδηγίες Συναρμολόγησης! | Μπάρες Οροφής |
| (TR) Öncelikle montaj:
Talimatlarını okuyunuz! | Taşıyıcı sistem |
| (RU) Инструкции по монтажу
Сначала прочитайте! | Багажники на крышу |
| (I) Istruzioni di montaggio
Leggere per primo! | Portabagagli |
| (NL) Montagehandleiding
Eerst lezen! | Imperiaal |
| (SLO) Navodila za sestavljanje
Preberite! | Strešne košare |



1.



(E) Contenido embalaje: ¡Verificar!

x 1

x 1

(GB) Package content: Check!



(F) Contenu d'emballage: Vérifier!

(D) Packungsinhalt: Überprüfen!

(PT) Contéudo embalagem:
Verificar!

(PL) Zawartość opakowania:
sprawdź!

(CZ) Obsah balení: Zkontrolujte!

(HU) Csomag tartalma: Ellenőrizd!

(RO) Pachetul contine: Verificati!

(HR) Sadržaj paketa: Provjeri!

(GR) Ελέγξτε το περιεχόμενο: του
πακέτου!

(TR) Paket içeriğini: Control ediniz!





(RU) Содержание упаковки:
Проверьте!

(I) Contenuto della confezione:
Controllare!

(NL) Pakket inhoud: Controleer!

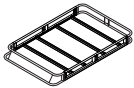
(SLO) Vsebina paketa: Preverite!

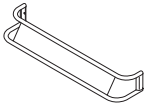
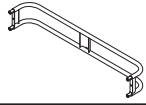
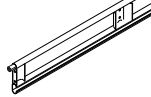
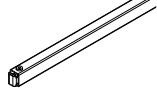
2.

Código Code	901-901	901-903	901-905
	Modul-Rack Safari A-110	Modul-Rack Safari A-126	Modul-Rack Safari A-140
←W→	110 cm	126 cm	140 cm
←L→	132 cm	132 cm	132 cm
	17,35 kg	18,83 kg	20,10 kg
Lote Lot	01/18	01/18	01/18
	1x (849-010)	1x (849-011)	1x (849-012)
	1x (849-015)	1x (849-016)	1x (849-017)
	1x (849-037I) 1x (849-037D)	1x (849-037I) 1x (849-037D)	1x (849-037I) 1x (849-037D)
	4x (827-411)	4x (827-412)	4x (827-414)
	1x (855-251) 1x (810-170)	1x (855-251) 1x (810-170)	1x (855-251) 1x (810-170)

3. 

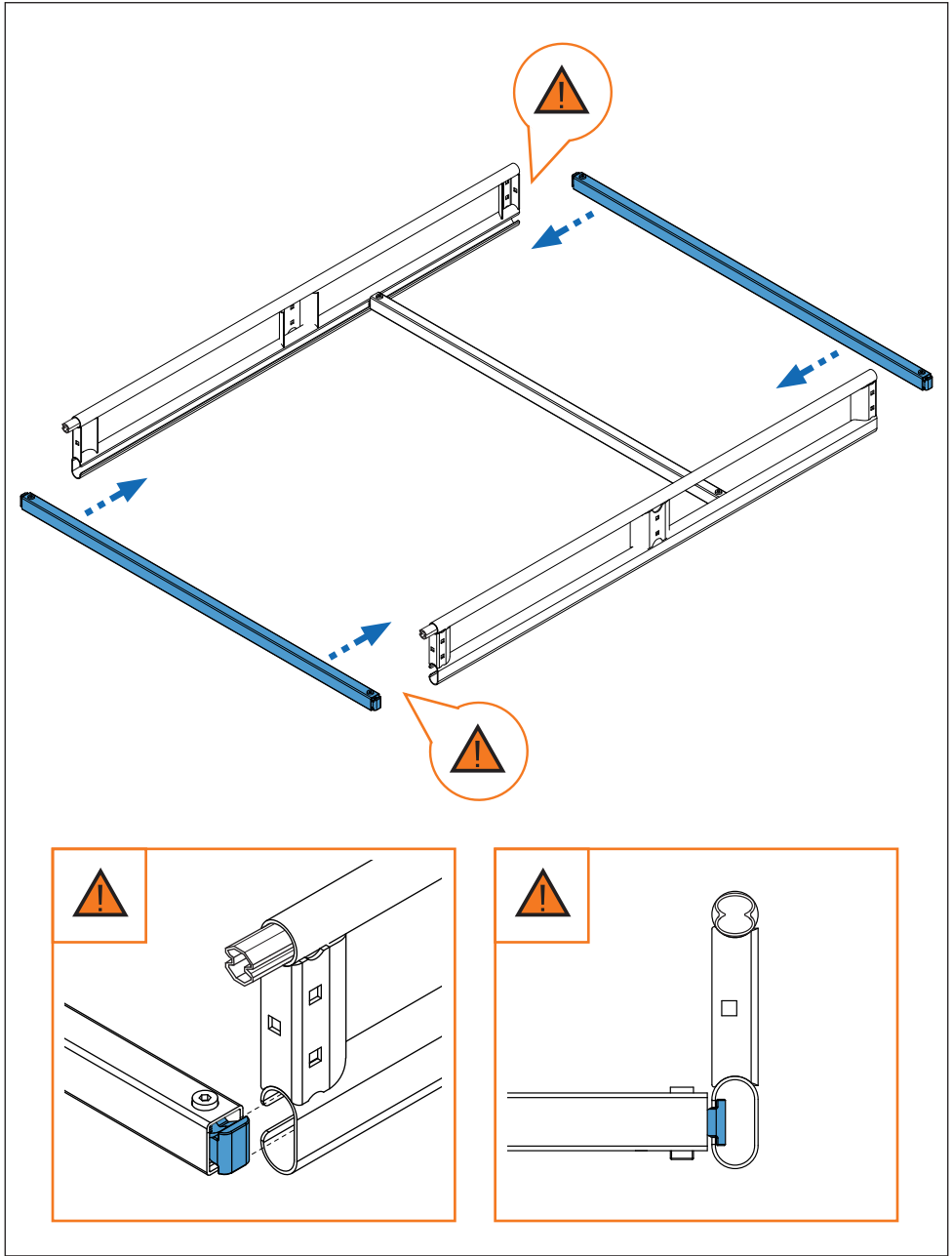

4. 

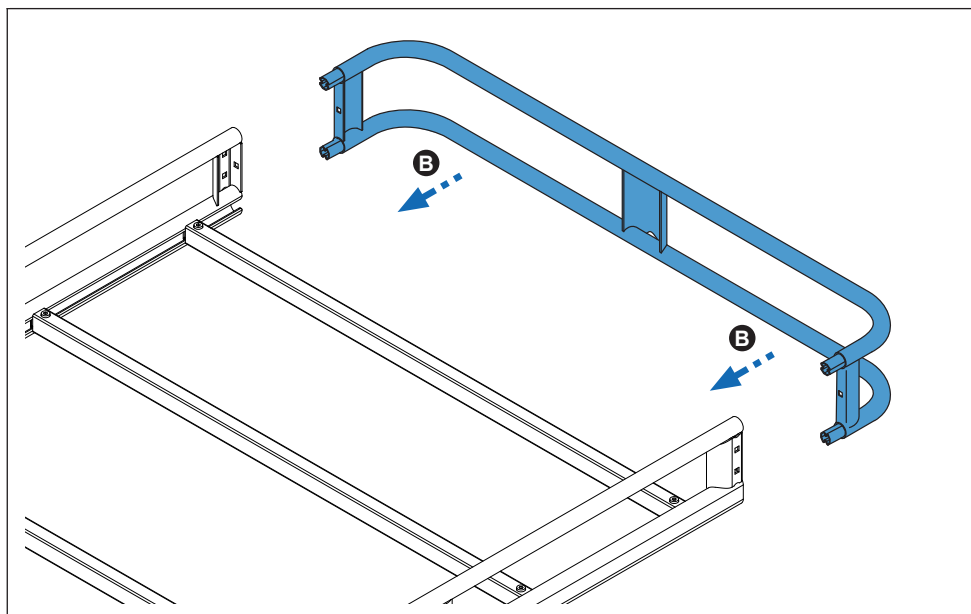
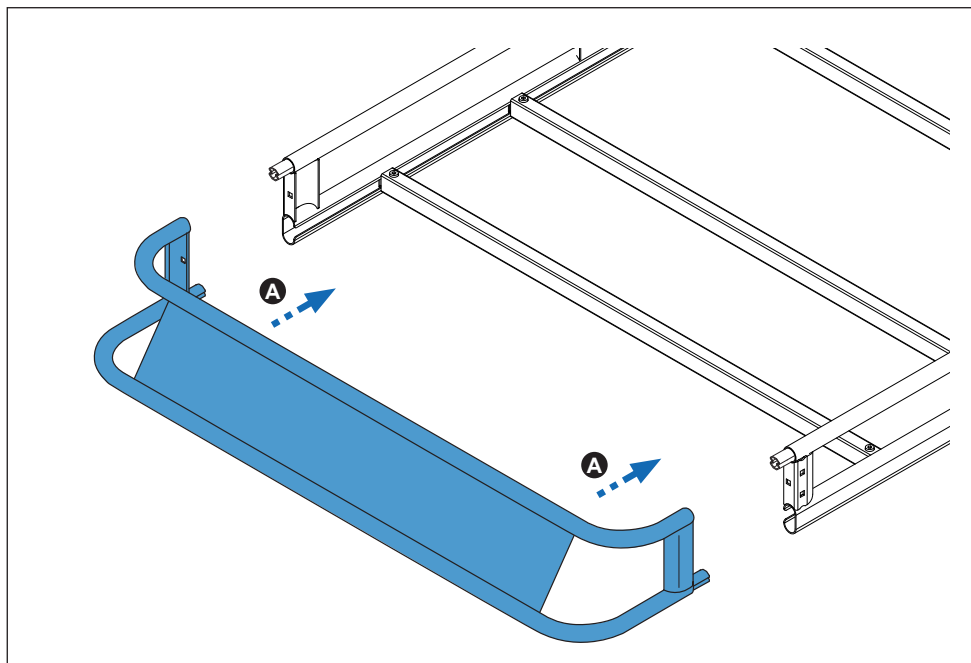

5. 

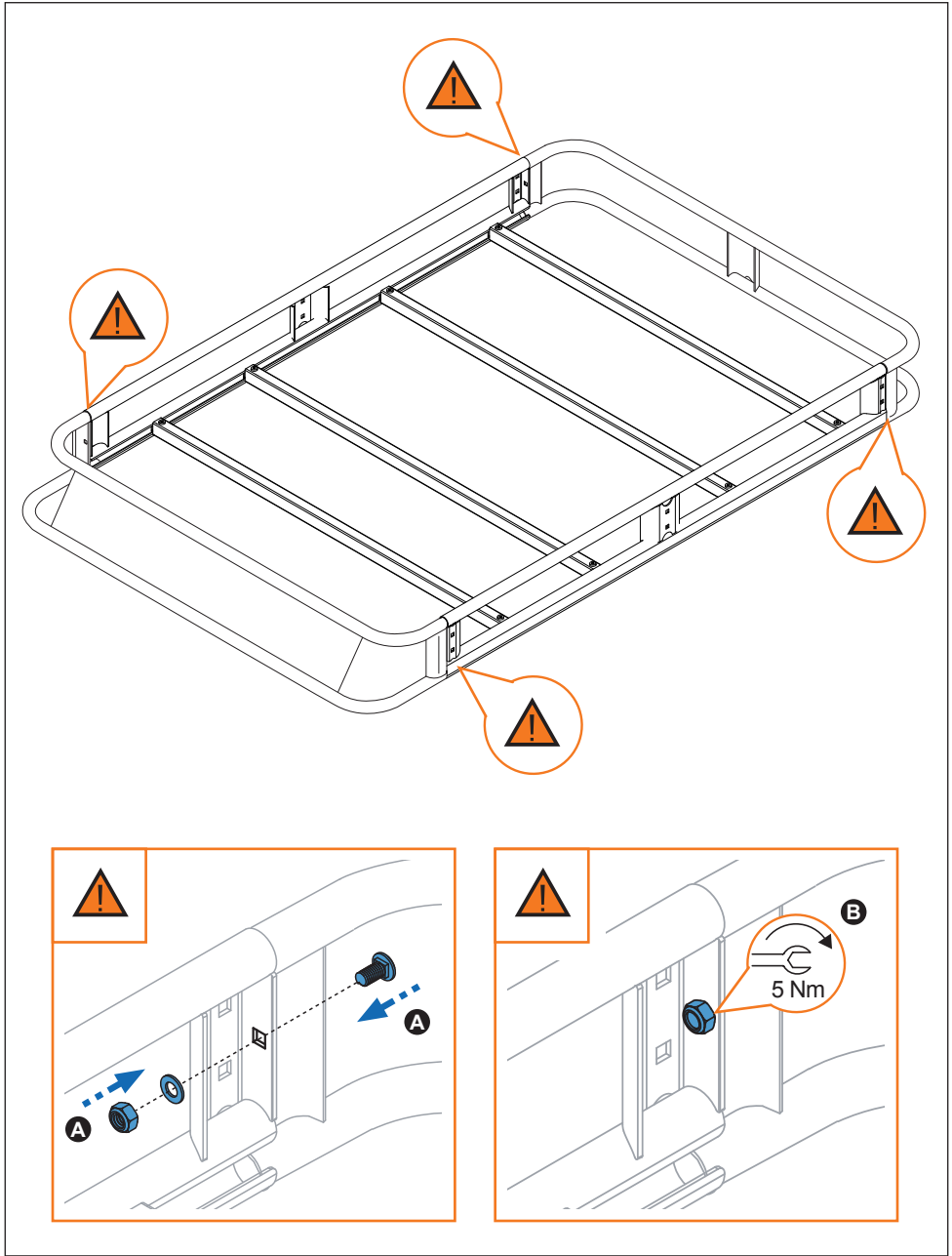

6. 

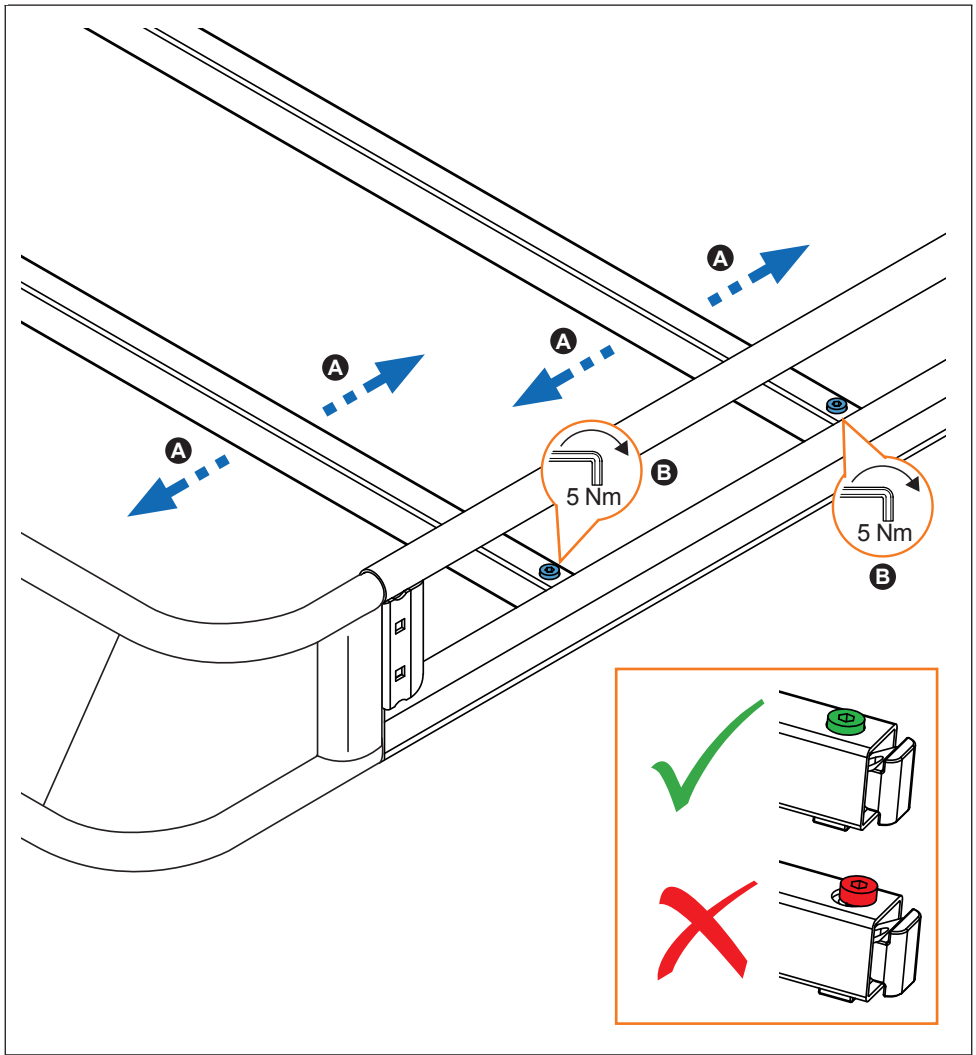
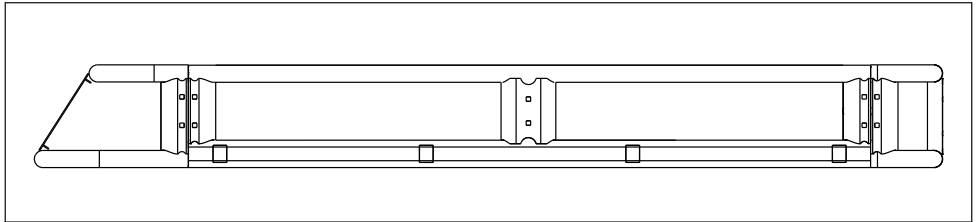

7. 

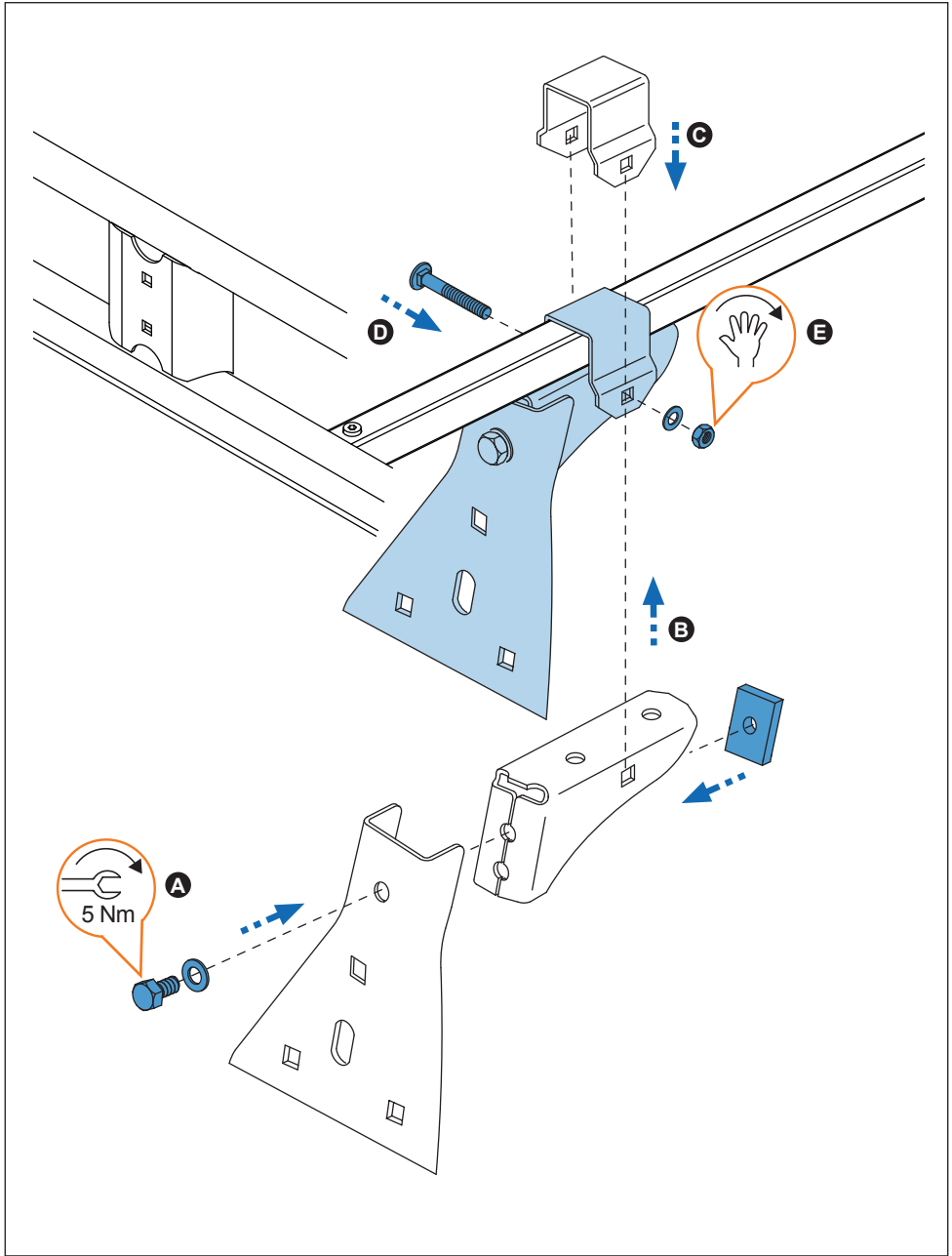

8. 

