

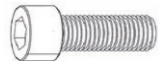

N	Q	Q
1	4	2
2	4	2
3		6
4		1

N	BO0061	Q
8	 DIN912 M6x20	24
9	 DIN125	24

N	BO0010 x 3	Q
10	 ISO 7380 M8x20	6
11	 Din125 Ø8	6

N	BO0006 x 3	Q
10	 DIN912 M6x16	6
11	 DIN9021 Ø6	6

- E** Instrucciones de montaje Kit de fijación
- C** Instruccions de muntatge Kit de fixació
- GB** Assembly instructions Fixation Kit
- F** Instruction de montage Kit fixation
- D** Montageanleitung Stützfuß-Kit
- PT** Instruções de montagem Kit fixação
- I** Istruzioni di montaggio Kit di fissaggio
- PL** Instrukcja montażu Element mocujący
- CZ** Montážní návod Fixační kit
- HU** Szerelési Utasítás Rögzítő készlet
- RO** Instrucțiuni de montaj Kit de fixare
- HR** Detaljne upute Kit za montažu
- TU** Öncelikle montaj Montaj kiti

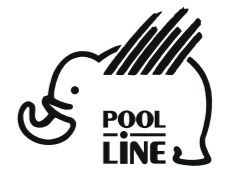

POOL-LINE ACCESORIOS, S.L.
C. Esqueis, 19. P. I. Can Barri
08415- Bigues i Riells. Barcelona (España)
www.pool-line.net

Nº HOMOLOGACIÓN: **E9** 26R-03.1043

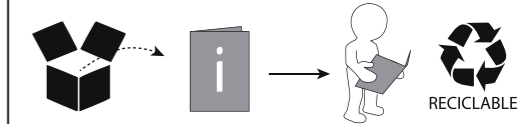

121751

Rv: 01/2021



Limpieza pre-instalación
Pre-installation cleaning

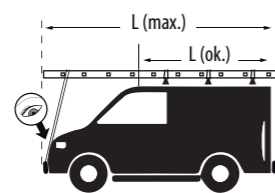

Revisar par de apriete
Check torque

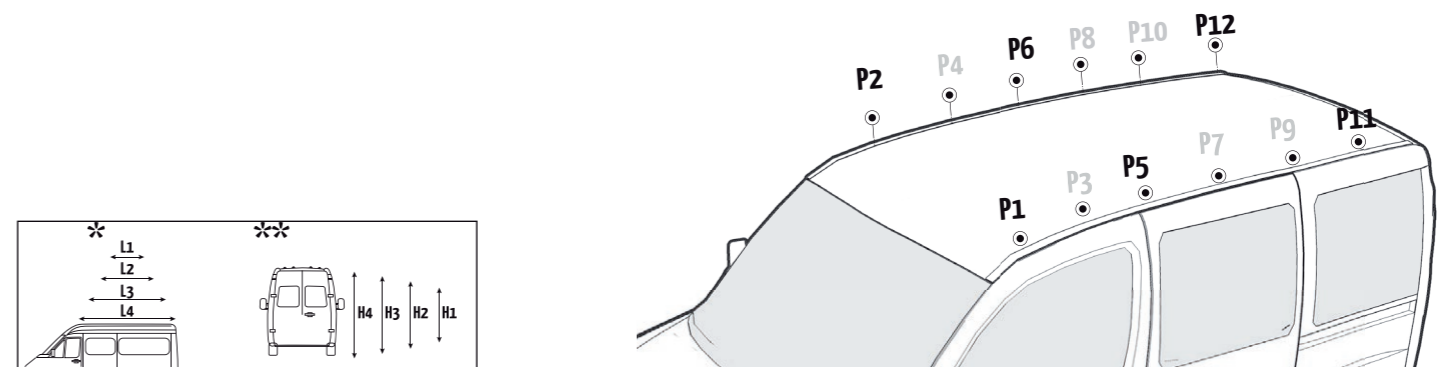

	L*	H**		10	P1	P2	P3	P4	P5	P6	P7	P8	P9	P10	P11	P12
FIAT DOBLO I	L1	H1	01-09	B00006	202+1A	202+1A			210+1B	210+1B					202+1A	202+1A
MERCEDES CITAN W415	L3	H1	12-21	B00010	202+1A	202+1A			210+1B	210+1B					202+1A	202+1A
NISSAN NV250	L2	H1	19-21	B00010	202+1A	202+1A			210+1B	210+1B					202+1A	202+1A
RENAULT KANGOO II	L3	H1	10-21	B00010	202+1A	202+1A			210+1B	210+1B					202+1A	202+1A

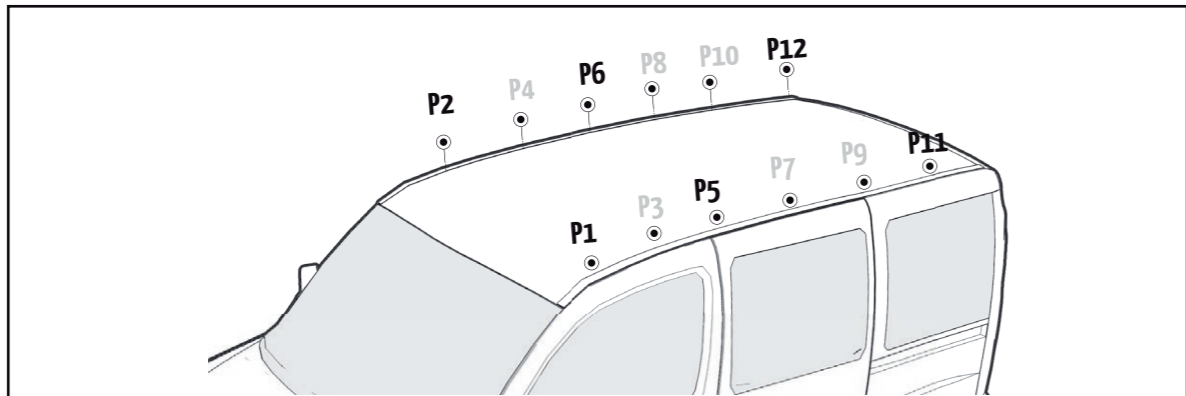

P1	P2	P3	P4	P5	P6	P7	P8	P9	P10	P11	P12
xxx	xxx			xxx	xxx					xxx	xxx
xxx											
xxx	xxx			xxx	xxx					xxx	xxx
xxx	xxx			xxx	xxx					xxx	xxx
xxx	xxx			xxx	xxx					xxx	xxx
xxx	xxx			xxx	xxx					xxx	xxx
xxx	xxx			xxx	xxx					xxx	xxx
xxx	xxx			xxx	xxx					xxx	xxx
xxx	xxx			xxx	xxx					xxx	xxx
xxx	xxx			xxx	xxx					xxx	xxx
xxx	xxx			xxx	xxx					xxx	xxx

Pag. 1

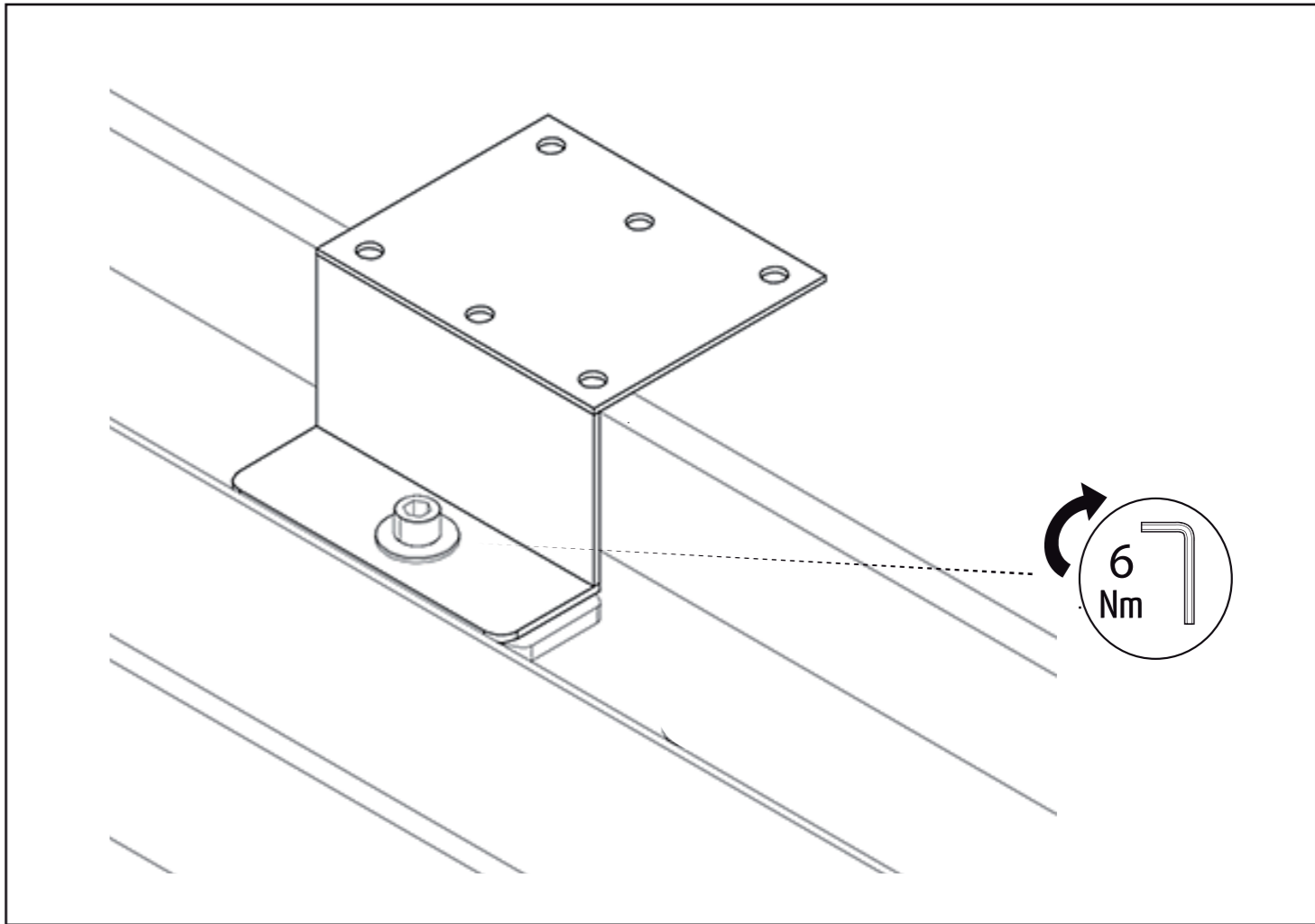

	P1	P2
0X	B0000XX	
0X-	B0000XX	
	B0000Y	

Pag. 1

