



AUTOHOME

MAGGIOLINA SERIES INSTRUCTIONS



WARNINGS

Avvertenze • Avertissement • Warnungen



MODELS Modelle Modèles Modelli	TENT WEIGHT Zeltgewicht Poids de la tente Peso della tenda	MAXIMUM OCCUPANTS WEIGHT Maximales Bewohnergewicht Poids Maximum des occupants Peso massimo degli occupanti	MEASURES WHEN CLOSE Abmessungen bei geschlossenem Zelt Dimensioni (tente fermée) Misure chiuse	MEASURES WHEN OPEN Abmessungen bei offenem Zelt Dimensions (tente ouverte) Misure aperte	INTERNAL VOLUME* Innervolumen Capacité interne de la tente Capacità interna
Airlander Small	ca. 59 kg	ca. 180 kg	130x210x30 cm	130x210x92 cm	ca. 196 l
Airlander Medium	ca. 64 kg	ca. 230 kg	145x210x30 cm	145x210x92 cm	ca. 220 l
Airlander Large	ca. 77 kg	ca. 280 kg	165x215x30 cm	165x215x92 cm	ca. 260 l
Extreme Small	ca. 64 kg	ca. 180 kg	130x210x33 cm	130x210x90 cm	ca. 203 l
Extreme Medium	ca. 68 kg	ca. 230 kg	145x210x33 cm	145x210x90 cm	ca. 228 l
GrandTour Small	ca. 60 kg	ca. 180 kg	130x210x36 cm	130x210x96 cm	ca. 344 l
GrandTour Medium	ca. 68 kg	ca. 230 kg	145x210x36 cm	145x210x96 cm	ca. 378 l
GrandTour Large	ca. 76 kg	ca. 280 kg	165x215x36 cm	165x215x96 cm	ca. 461 l
Plus Small	ca. 59 kg	ca. 180 kg	130x210x30 cm	130x210x92 cm	ca. 196 l
Plus Medium	ca. 64 kg	ca. 230 kg	145x210x30 cm	145x210x92 cm	ca. 220 l
Plus Large	ca. 77 kg	ca. 280 kg	165x215x30 cm	165x215x92 cm	ca. 260 l
Plus Small X-Long	ca. 65 kg	ca. 180 kg	130x230x30 cm	130x230x92 cm	ca. 210 l
Plus Medium X-Long	ca. 70 kg	ca. 230 kg	145x230x30 cm	145x230x92 cm	ca. 235 l
Plus 360 X-Large	ca. 90 kg	ca. 280 kg	180x230x30 cm	180x230x92 cm	ca. 300 l
Carbon Fiber Small	ca. 51 kg	ca. 180 kg	130x210x30 cm	130x210x92 cm	ca. 196 l
Carbon Fiber Medium	ca. 57 kg	ca. 230 kg	145x210x30 cm	145x210x92 cm	ca. 220 l

The GRP (fiberglass) outer shells are all handmade and finished, therefore some variations may appear in the finished weights (Manufacturers tolerance rate is within 10%).

Da die Herstellung der Glasfaserschalen manuell erfolgt, können unterschiedliche Zeltgewichte auftreten.

(Da es sich bei Dachzelten um handwerklich gefertigte Produkte handelt, sind Abweichungen bei Gewichten und Abmessungen im Rahmen üblicher Toleranz (10% möglich).

La production des coques en fibre résine est réalisée à la main, raison pour laquelle il est possible de noter des différences de poids au niveau de la tente (la marge de tolérance de fabrication est de l'ordre de 10%).

La produzione dei gusci in vetroresina è realizzata manualmente, di conseguenza è possibile riscontrare delle variazioni del peso della tenda (la tolleranza nell'ambito della costruzione di fabbrica è del 10%).

(*) Approximate value indicating the volumetric capacity of the upper shell of the tent, when the tent is closed

Ungefähres Volumen des Stauraums in der oberen Zeltschale, bei geschlossenem Zustand.

Valeur approximative indiquant la capacité volumétrique de la coque supérieure lorsque la tente est fermée

Valore approssimativo che indica, a tenda chiusa, la capacità volumetrica del guscio superiore.

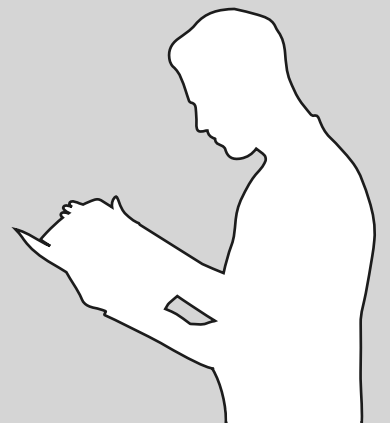
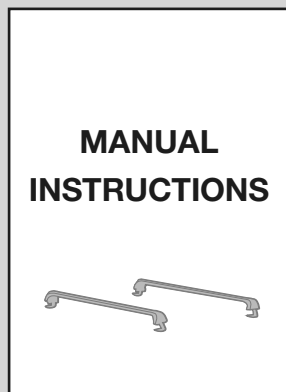
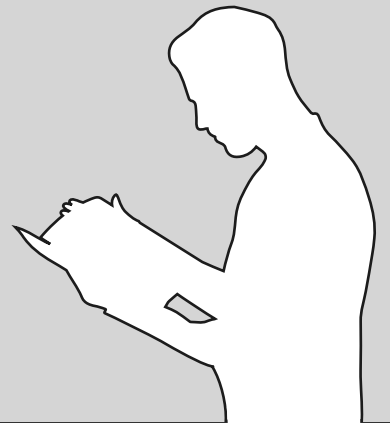
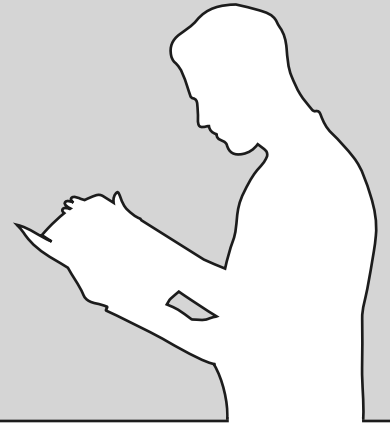
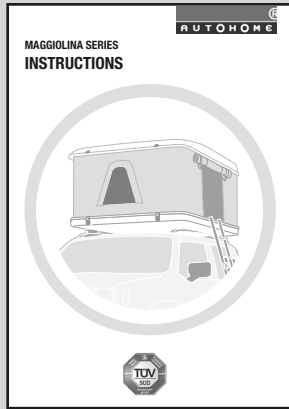

Kg P₁



Kg P₂



Kg P₃

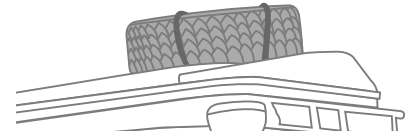

ONLY FOR EXTREME MODEL

$$(P_1 + P_2 + P_3) \leq \text{Kg } P_{MAX}$$

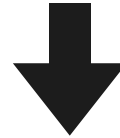

Kg P_{MAX}

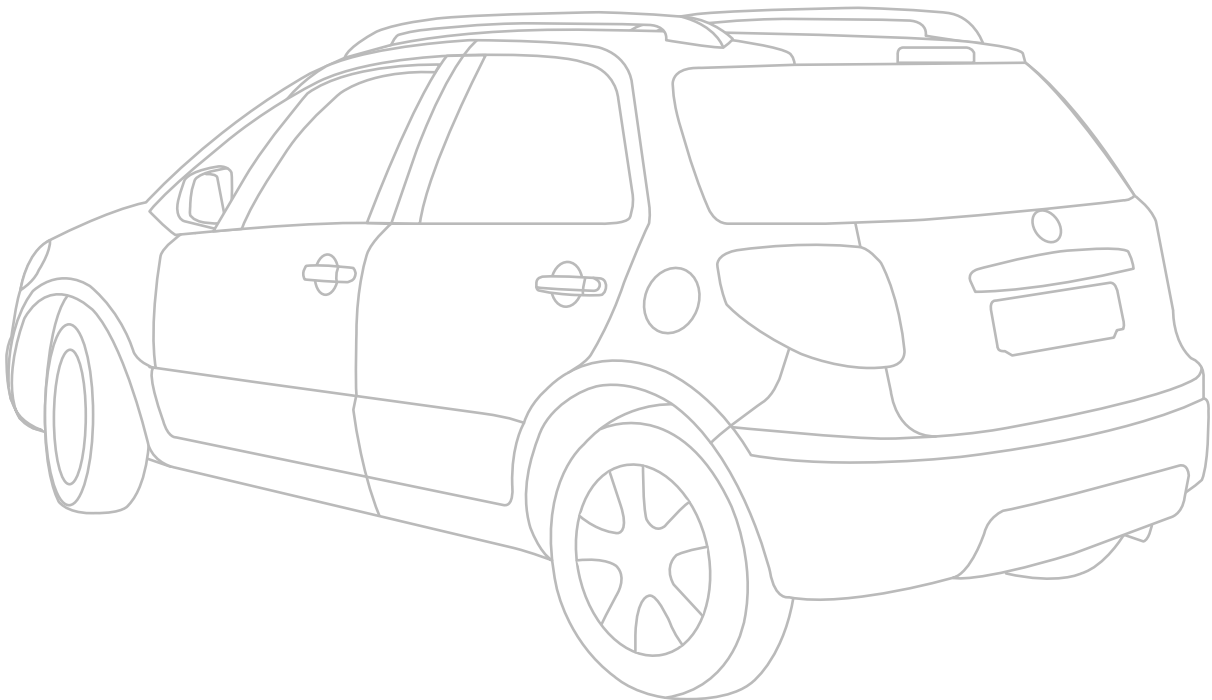
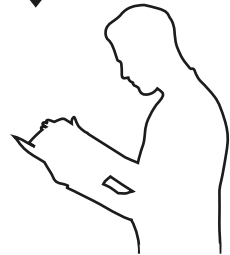
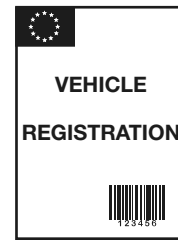

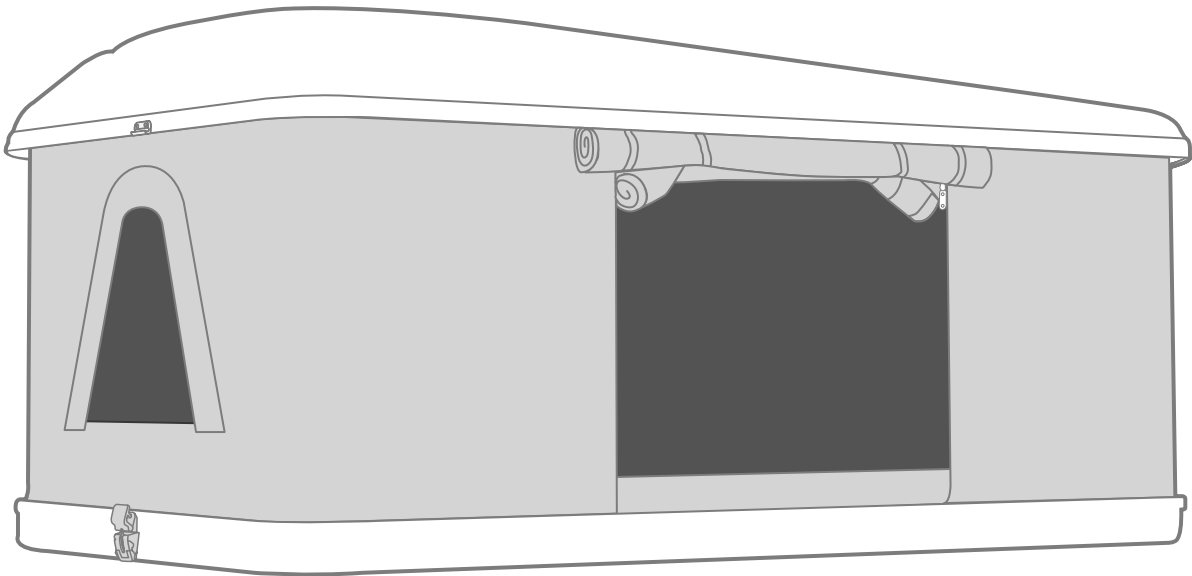

UP

UNDER

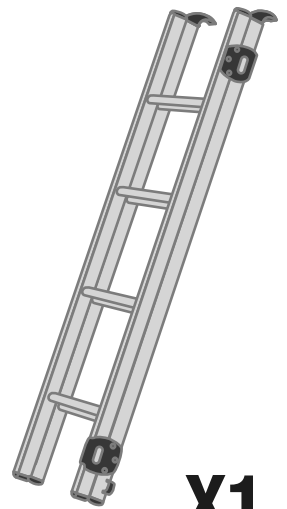
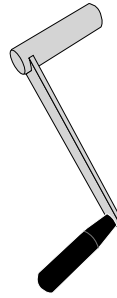
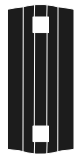

X8

X8

X4

X8

X1

X1

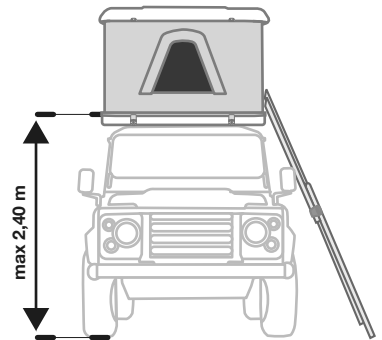
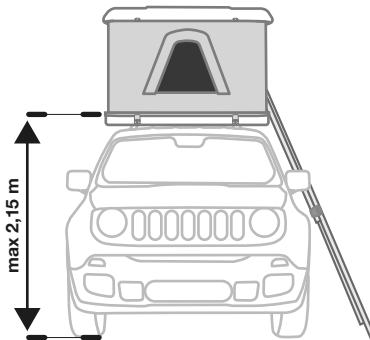
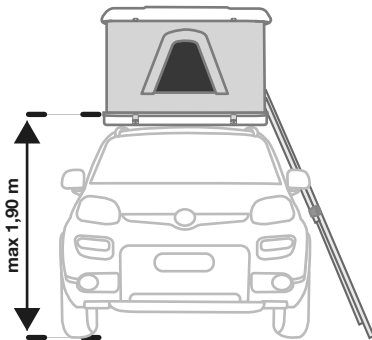

Ladder	H closed	H opened	Width	Thickness
STANDARD	120 cm	200 cm	34 cm	8 cm
4X4	130 cm	222 cm	34 cm	8 cm
EXTRA LONG	147 cm	247 cm	34 cm	8 cm

POSITIONING

Posizionamento • Placement • Platzierung

1

Minimum length

Lunghezza minima • Longueur minimale • Mindestlänge

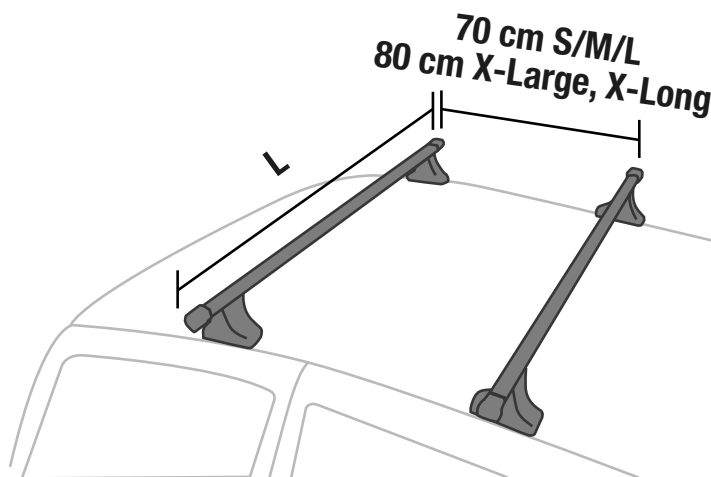

ROOF TENT	L
Maggiolina Small	120 cm
Maggiolina Medium	140 cm
Maggiolina Large	160 cm
Maggiolina X-Large	180 cm

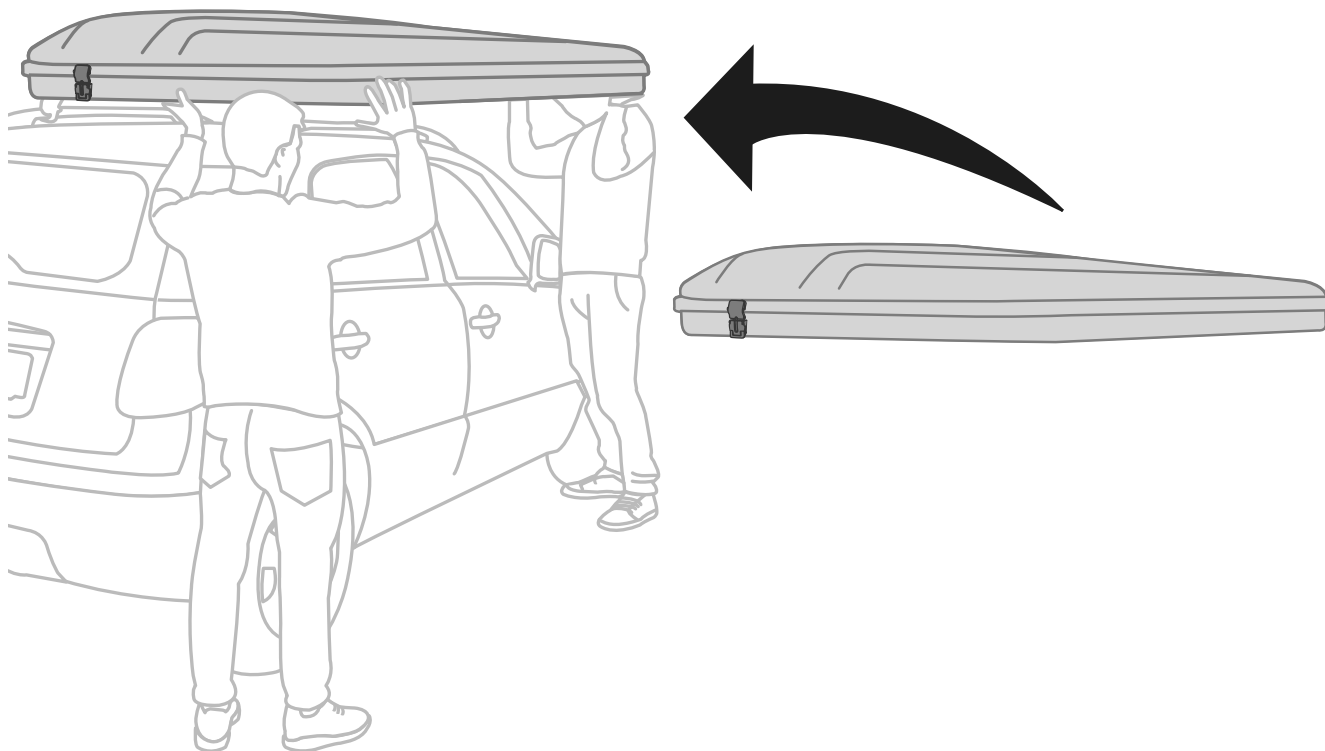

2

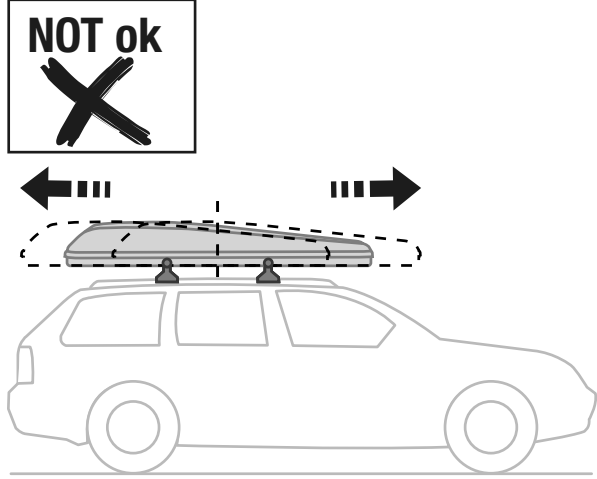
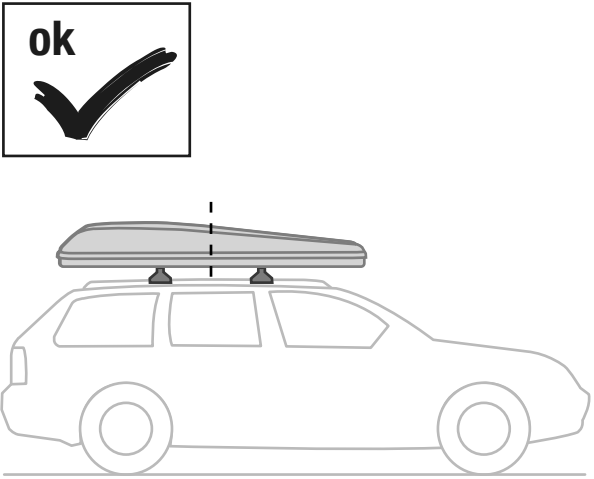
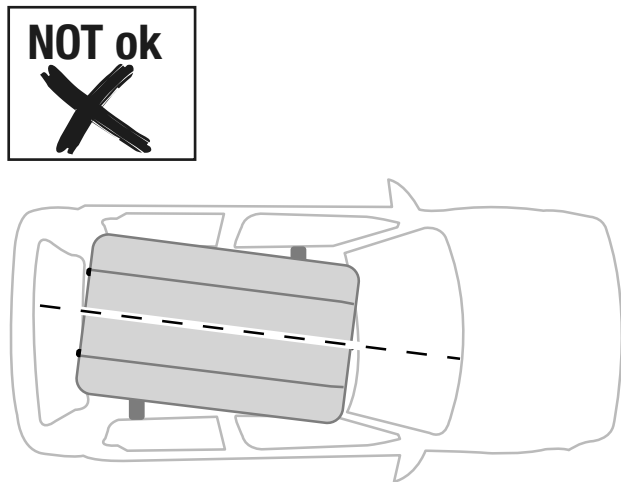
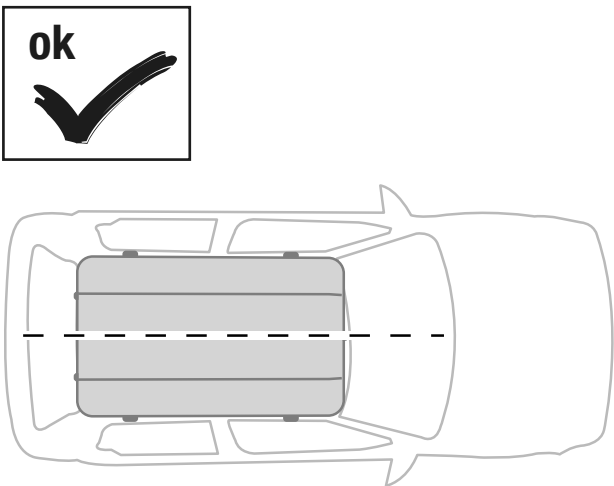
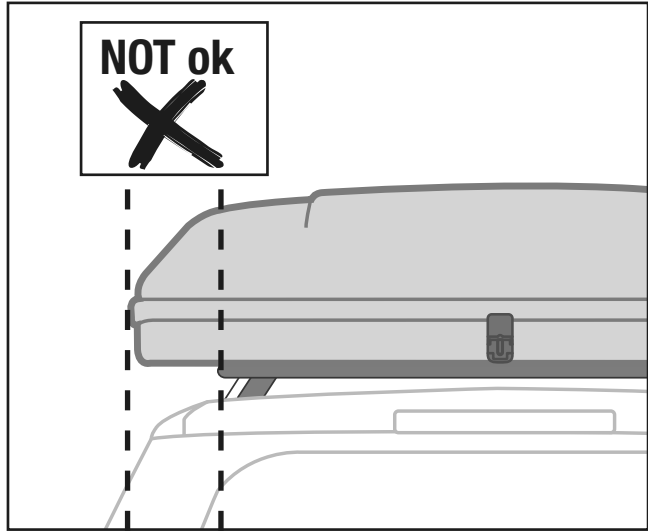
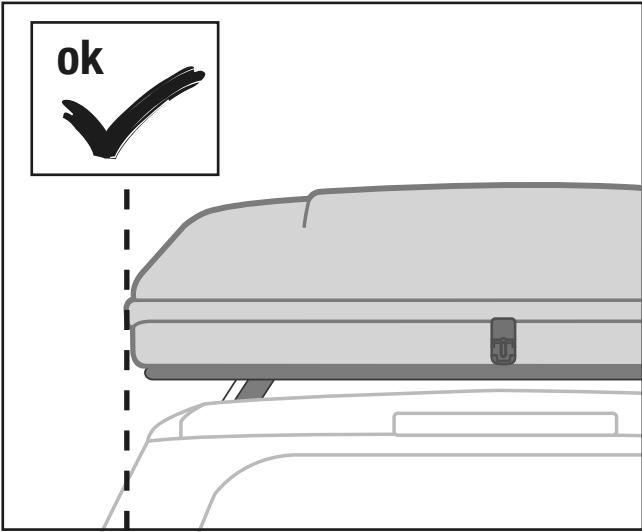

FIXING

Fissaggio • Fixation • Befestigung

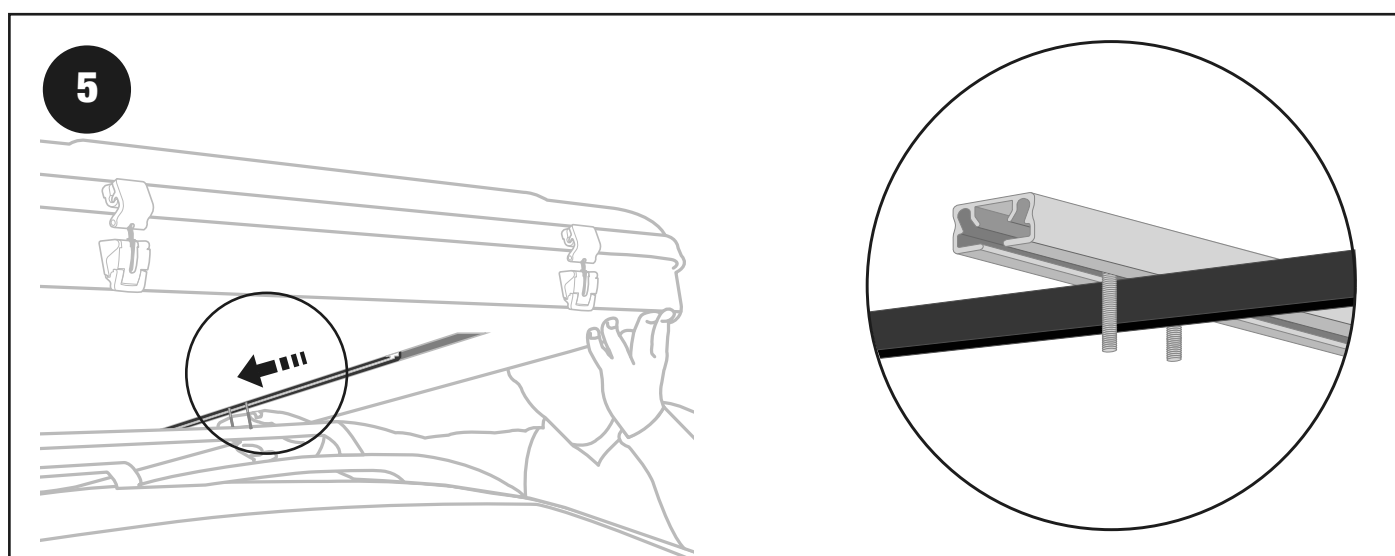
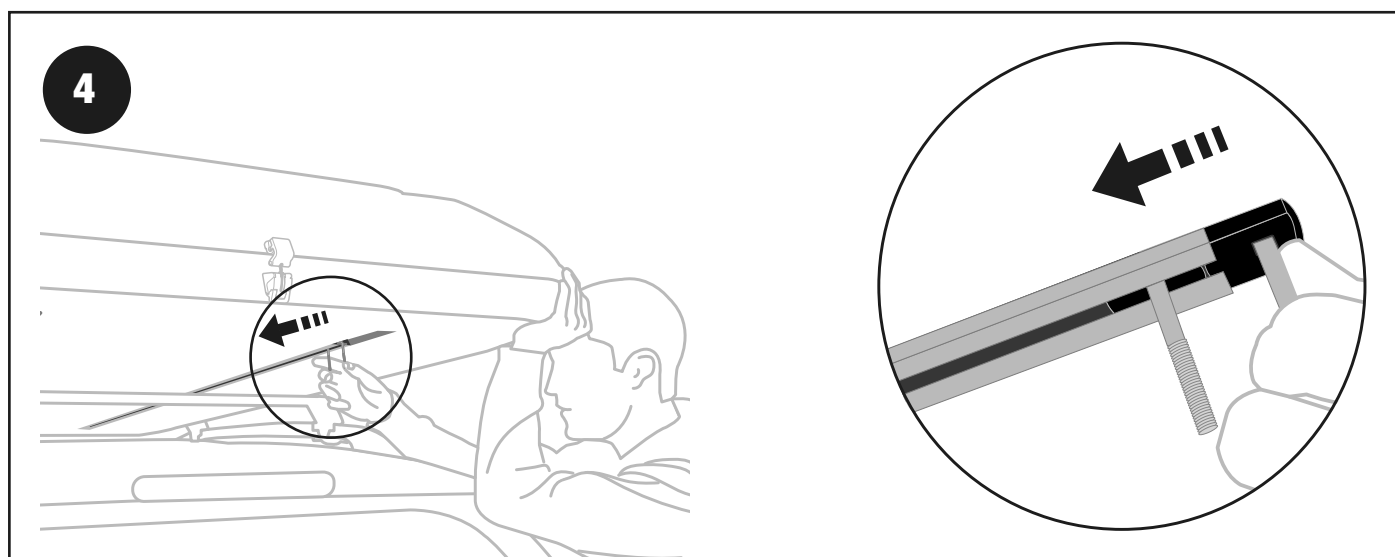
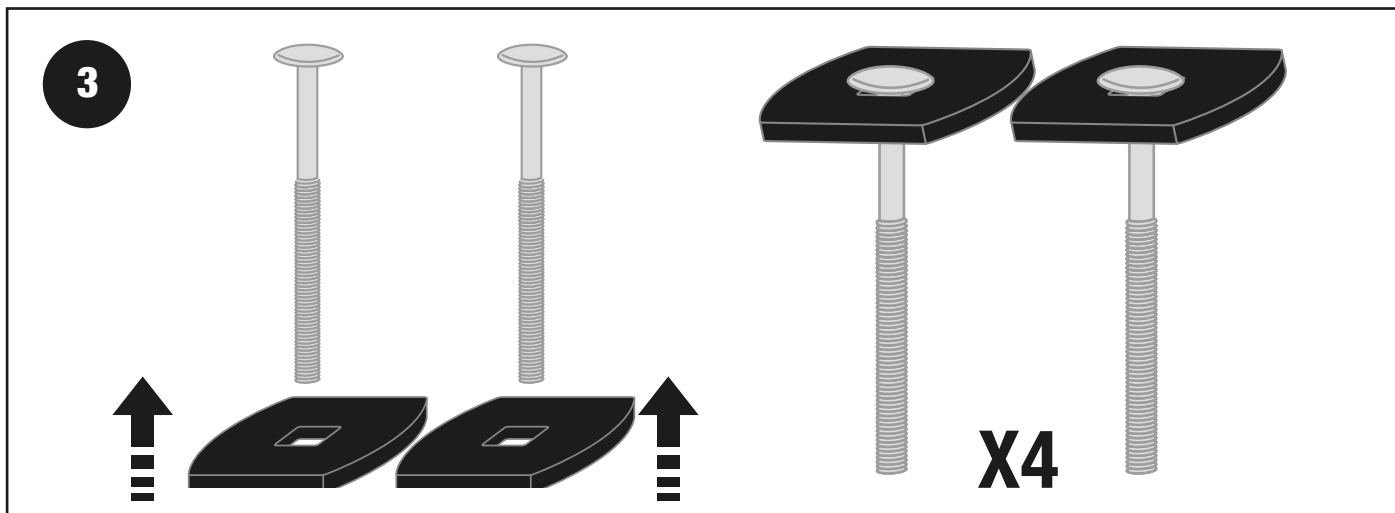

6

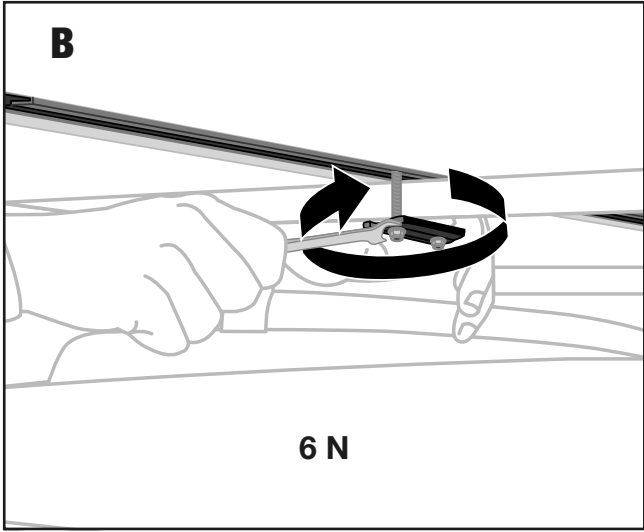
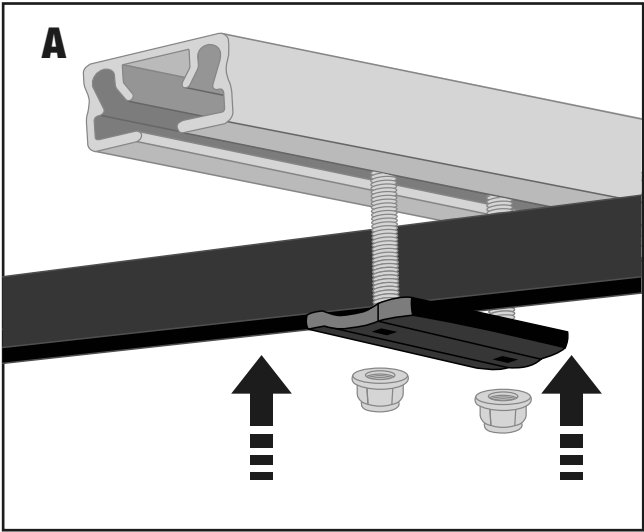

7

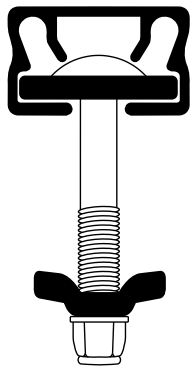
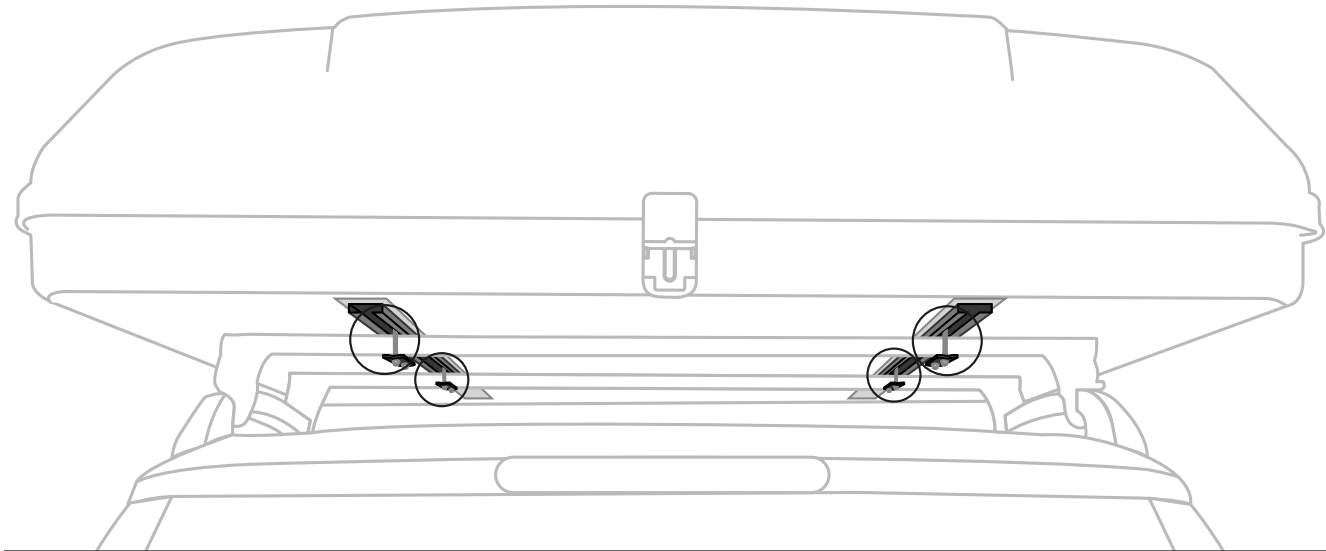

X4

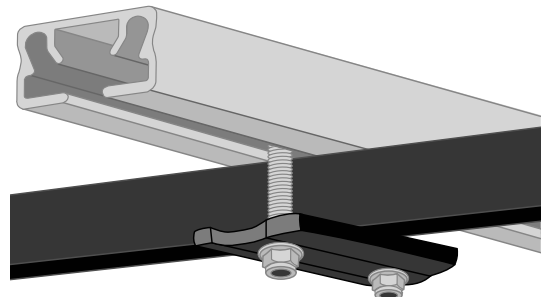

OPENING

Apertura • Overture • Öffnung

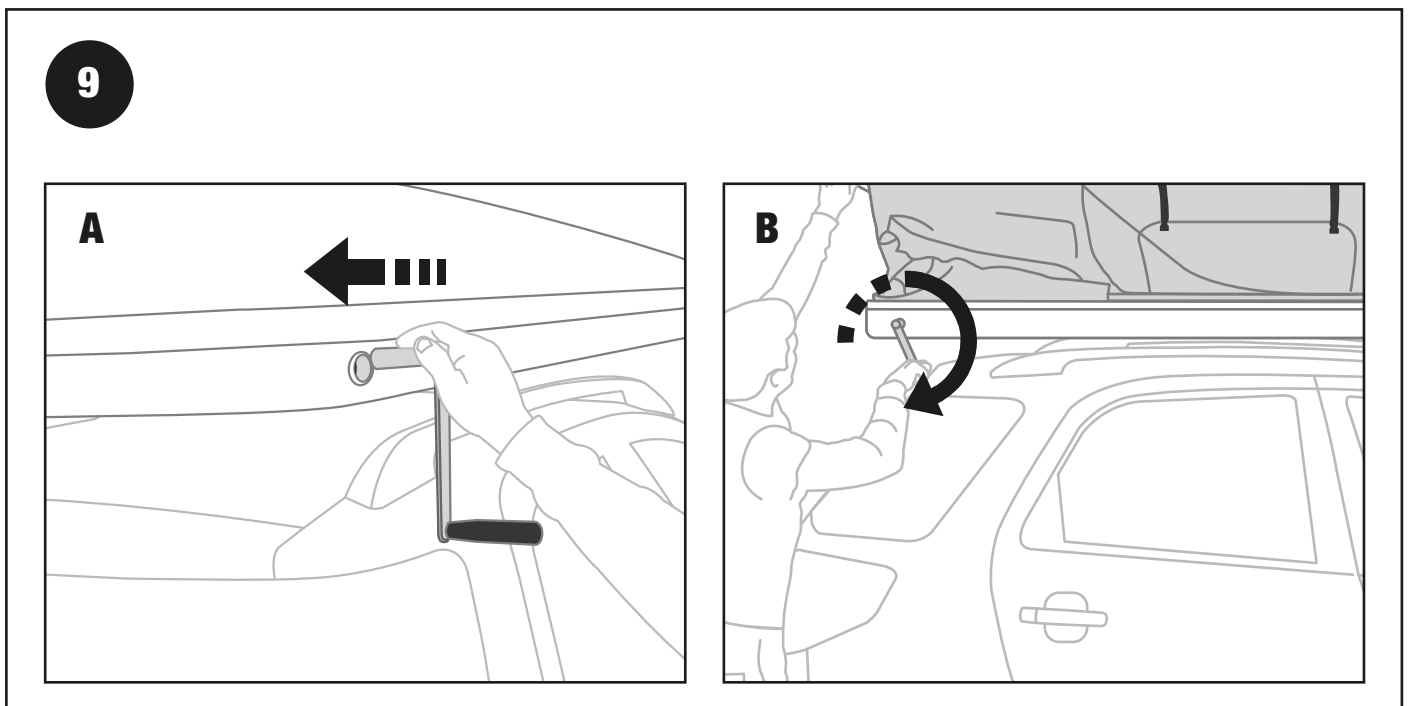
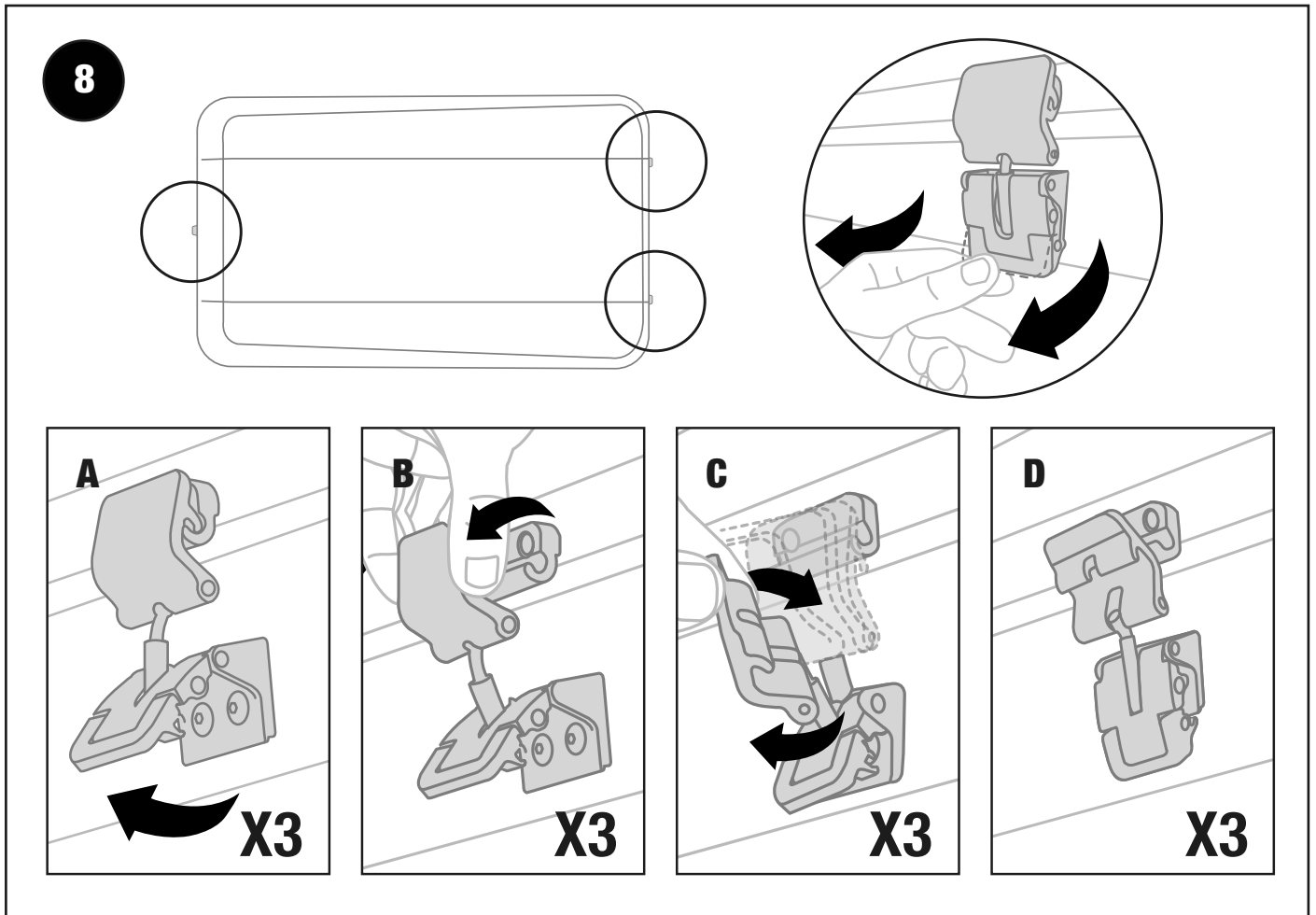

10

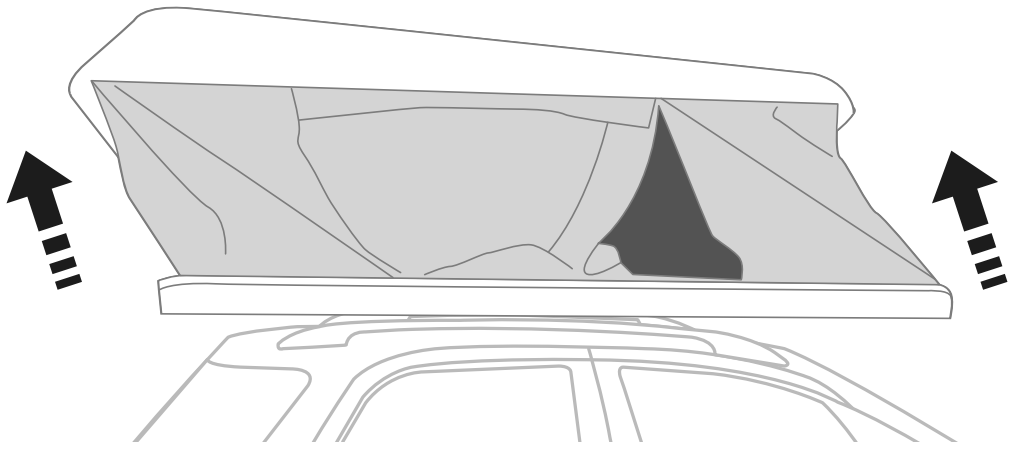
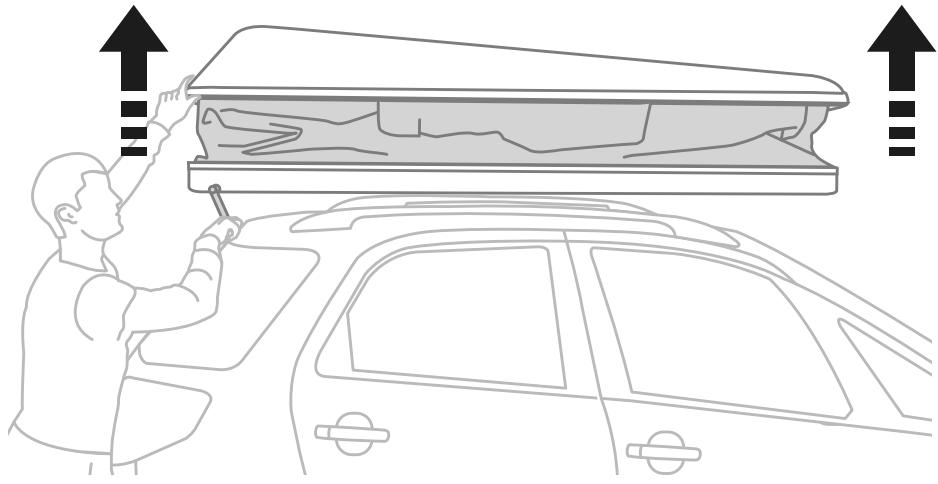

11

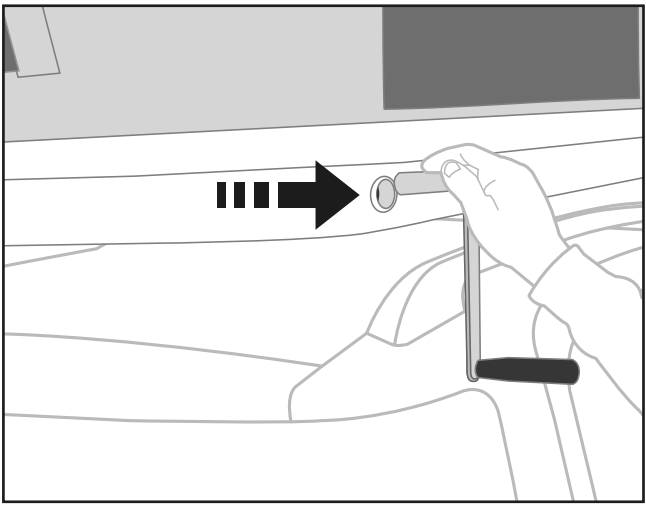

WARNINGS

Avvertenze • Avertissement • Warnungen



12

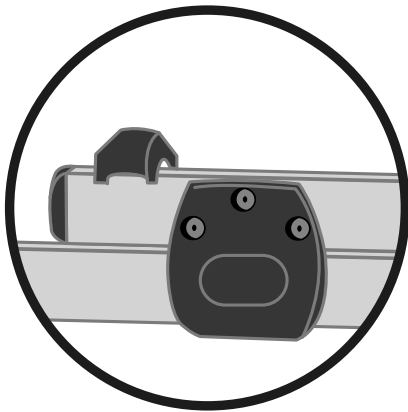
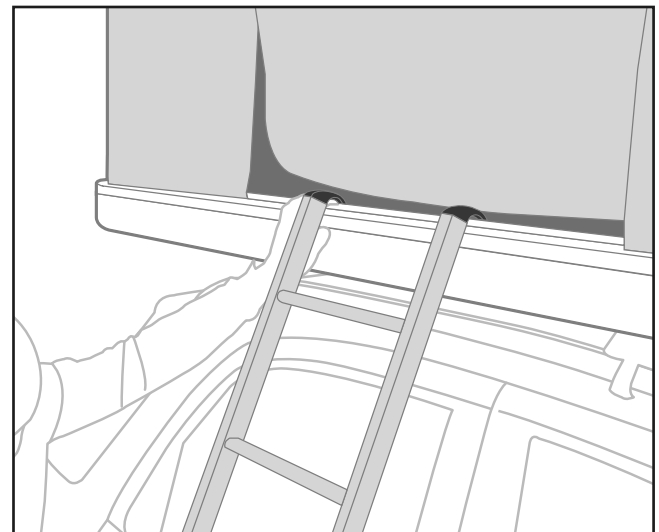
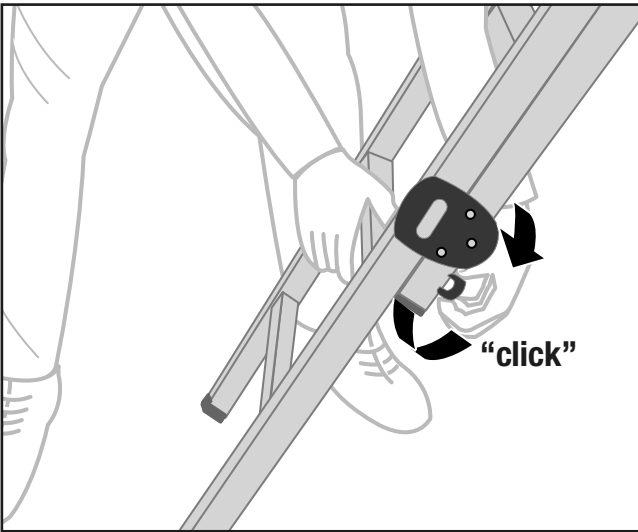
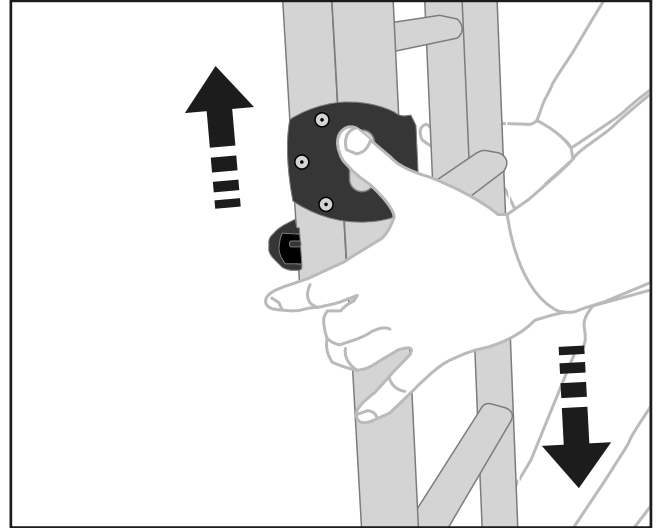
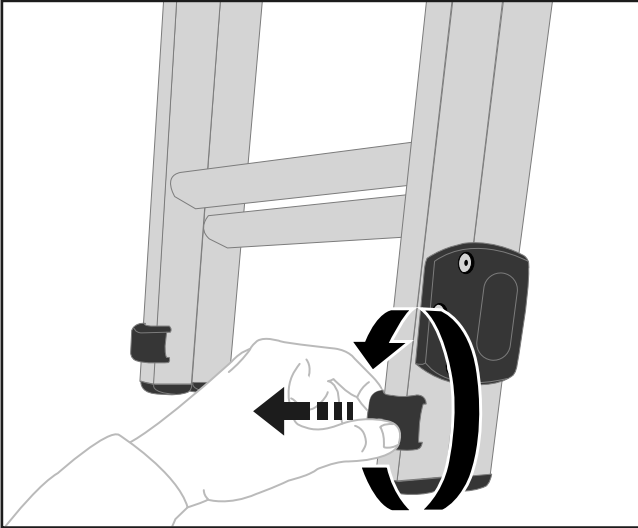

LOCK

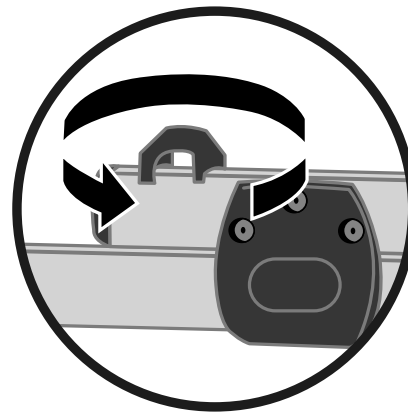

UNLOCK

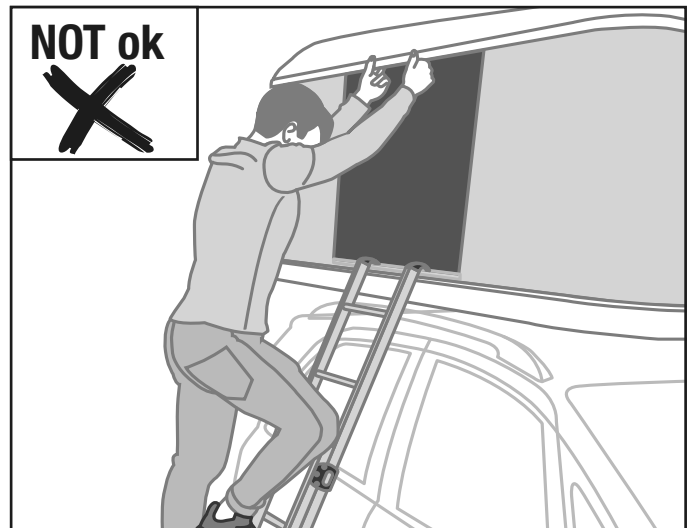
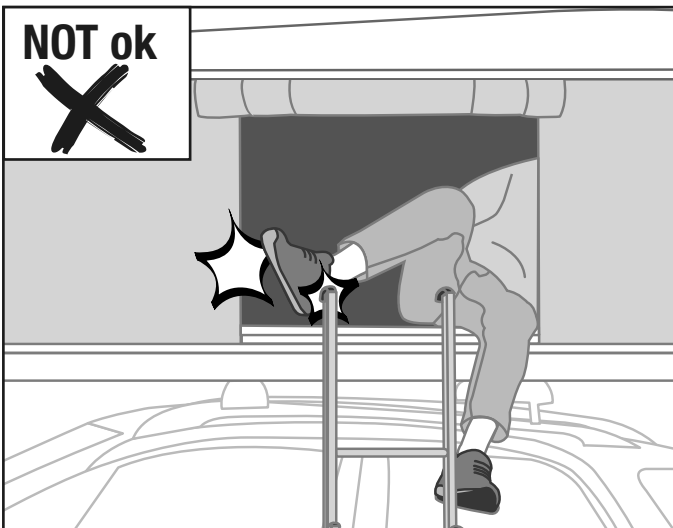
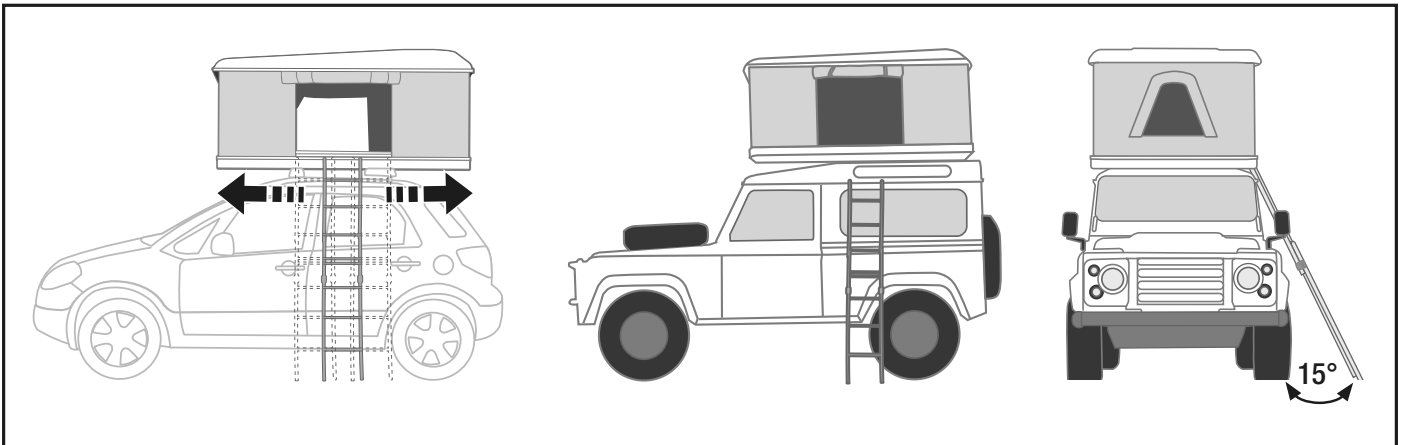
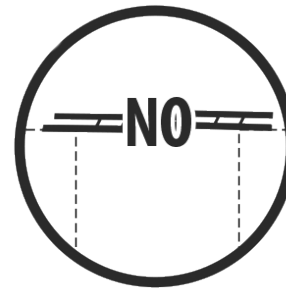
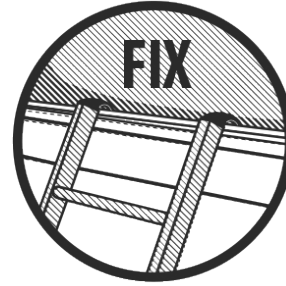
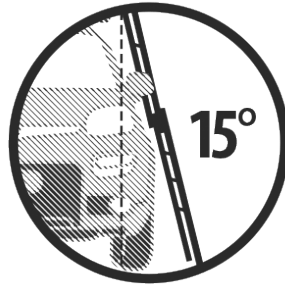

CLOSING

Chiusura • Fermeture • Schließung

13

 **ATTENTION**

NOT ok

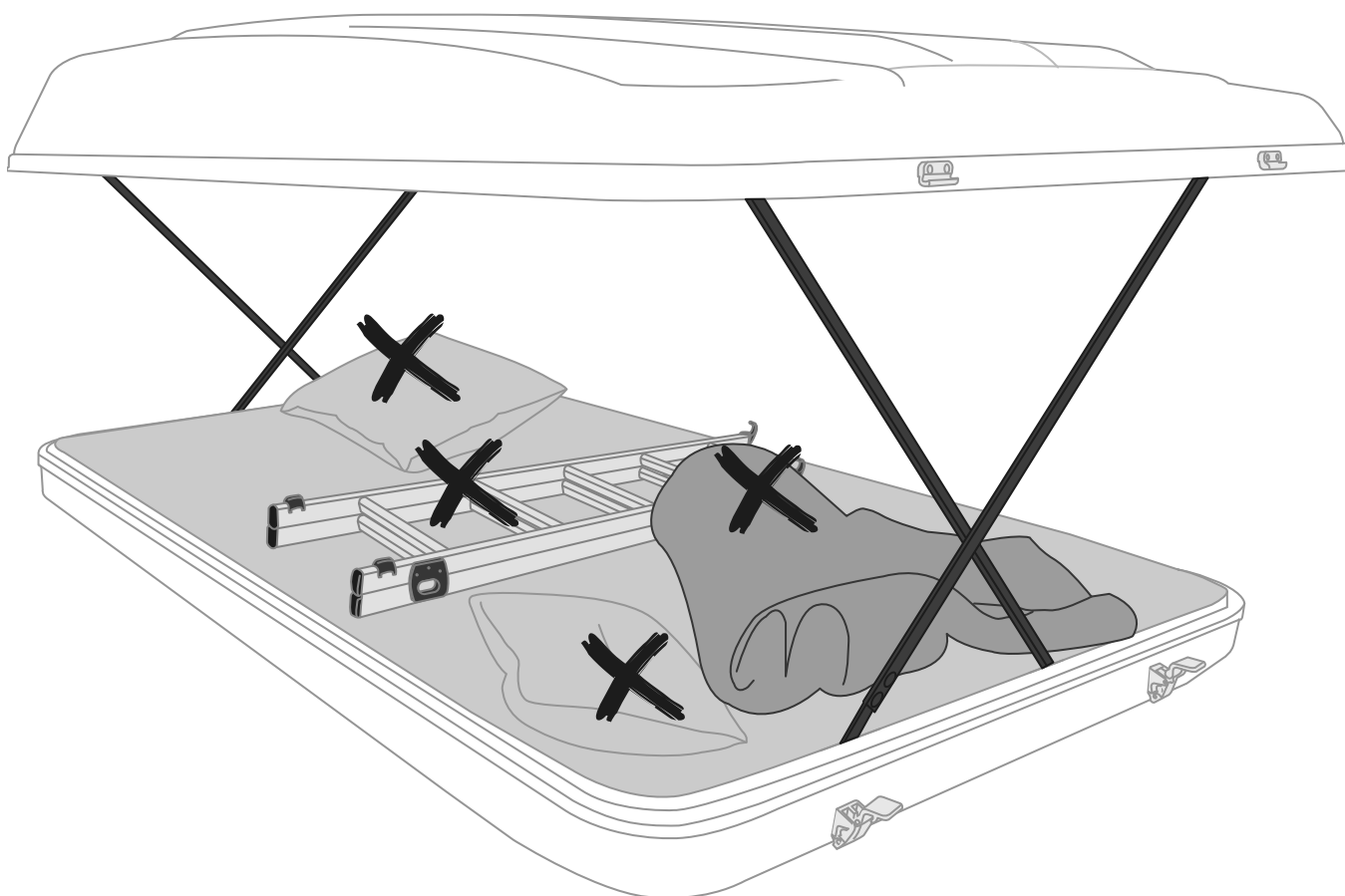

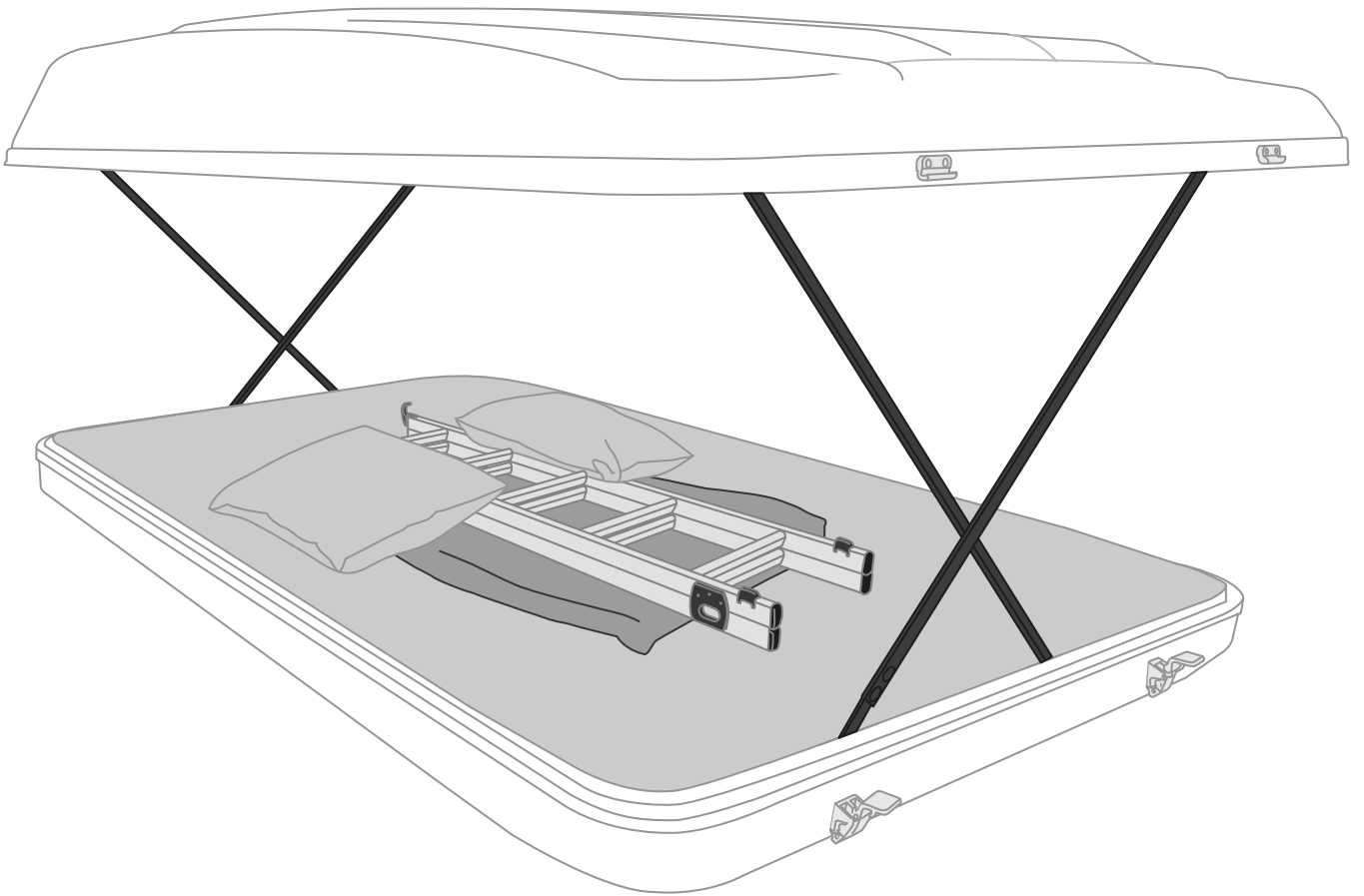

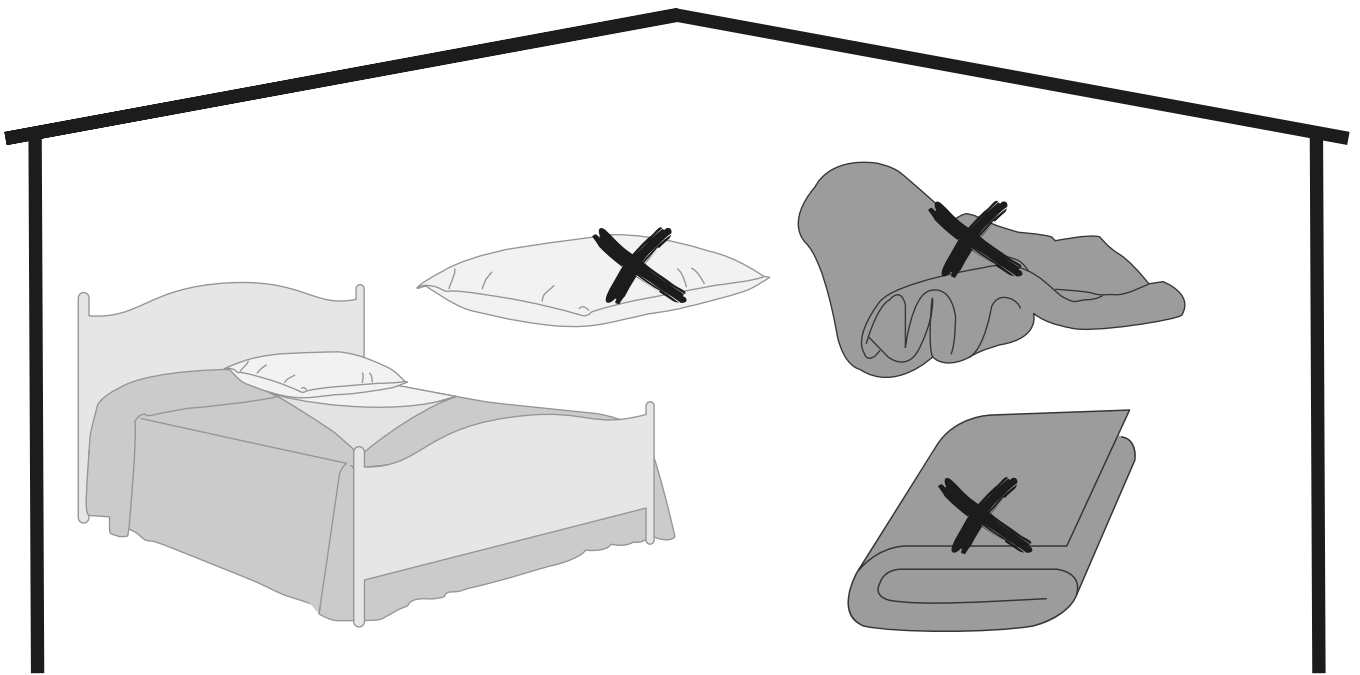
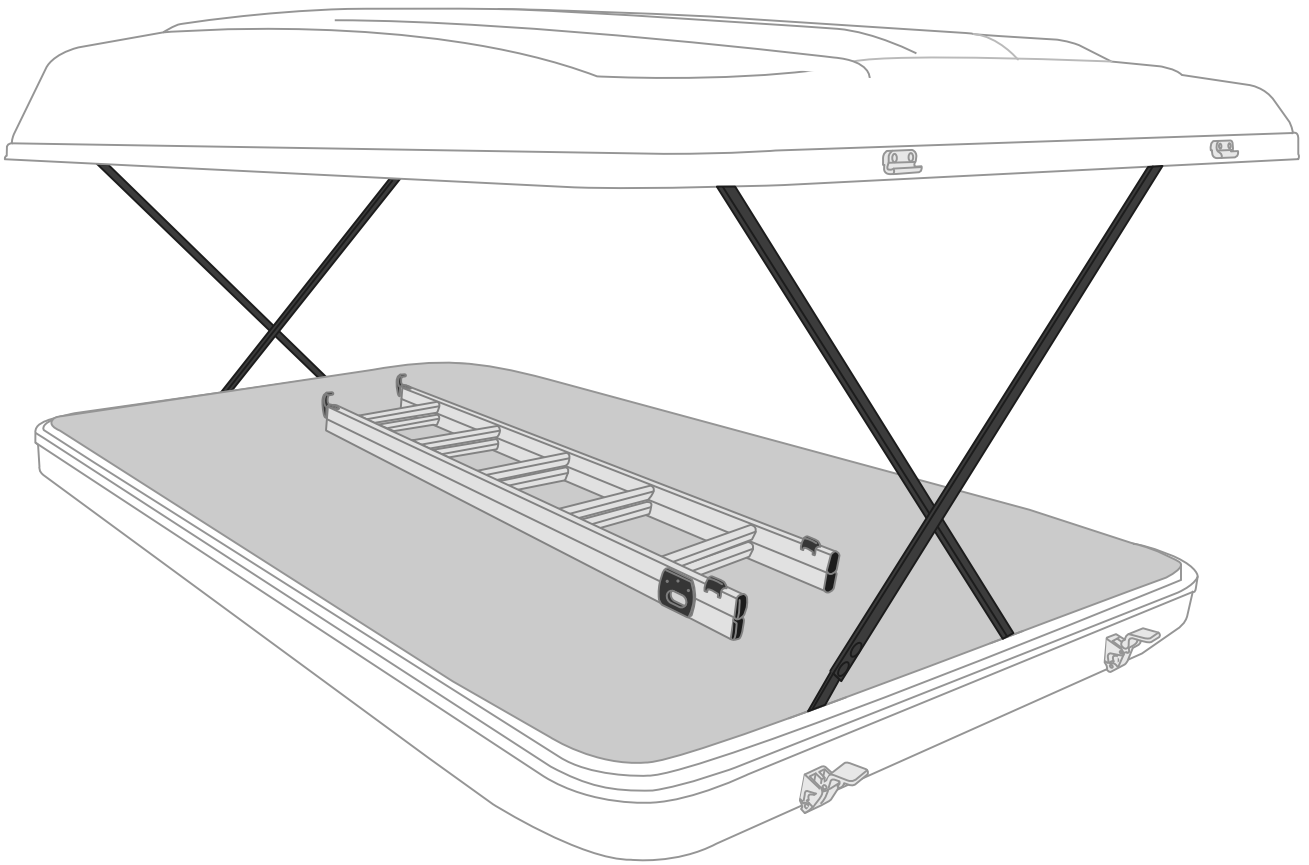
14

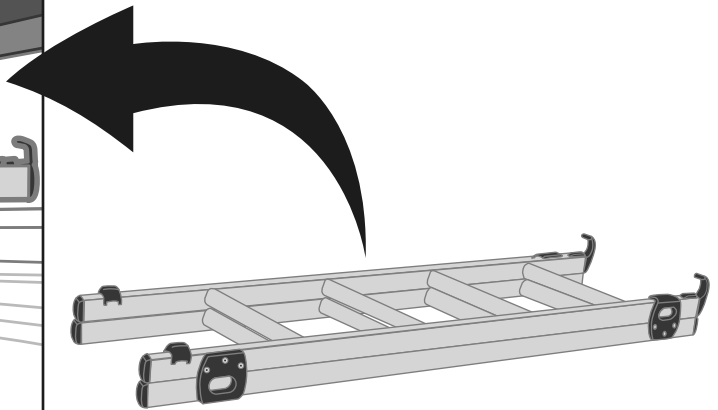
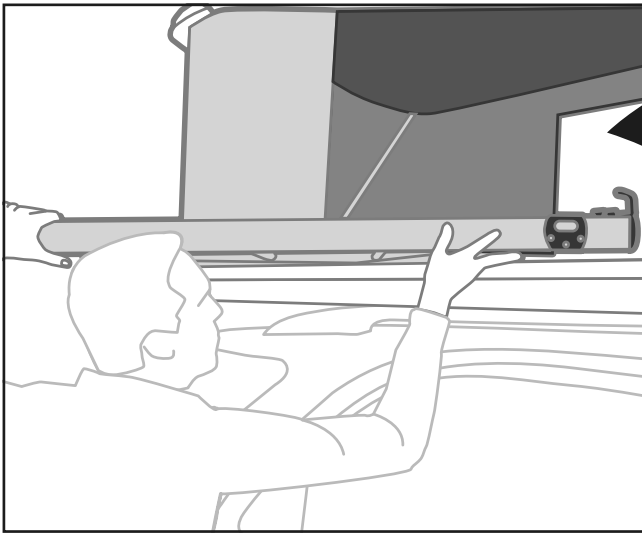

18-20 cm

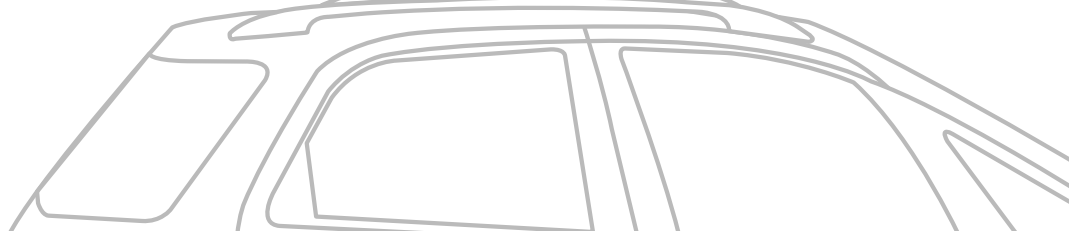
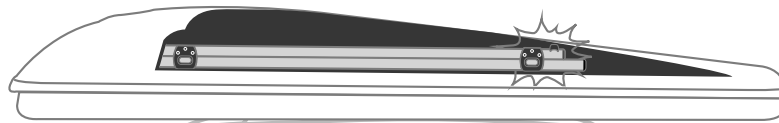
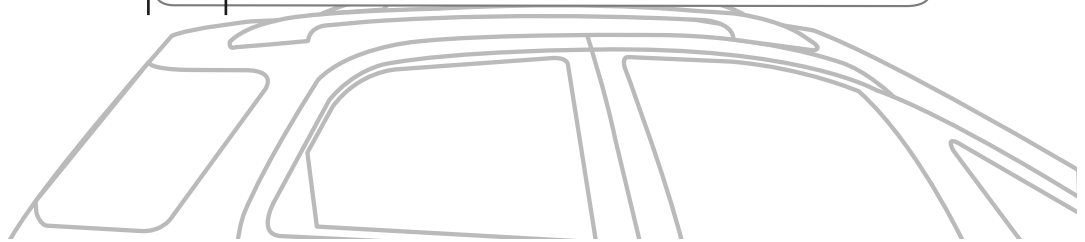

	MAGGIOLINA SMALL	MAGGIOLINA MEDIUM	MAGGIOLINA LARGE	MAGGIOLINA SMALL EXTRA LONG	MAGGIOLINA MEDIUM EXTRA LONG
Standard ladder	✓ ok	✓ ok	✓ ok	✓ ok	✓ ok
Ladder 4X4	✗ NOT ok	✗ NOT ok	✗ NOT ok	✓ ok	✓ ok
Extra Long ladder	✗ NOT ok	✗ NOT ok	✗ NOT ok	✓ ok	✓ ok

15

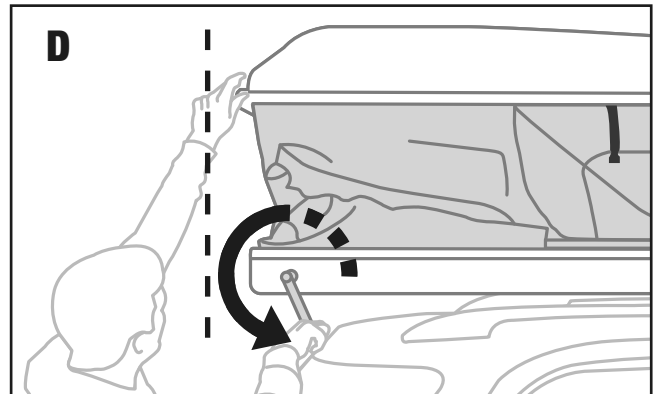
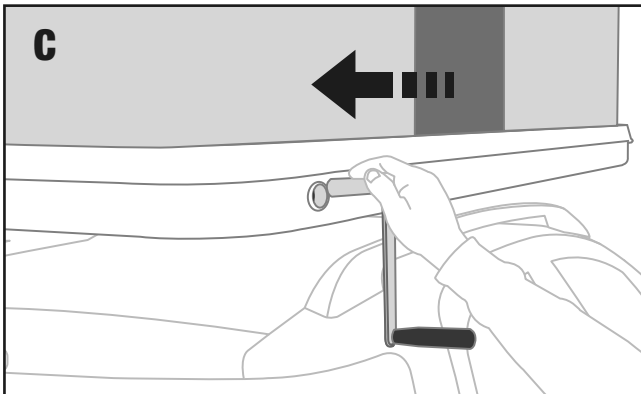
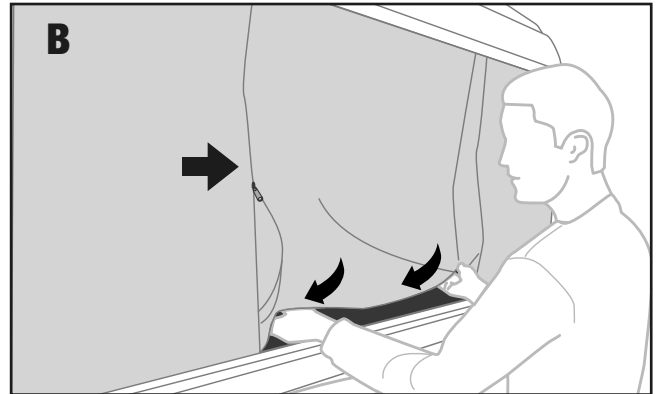

WARNINGS

Avvertenze • Avertissement • Warnungen



16

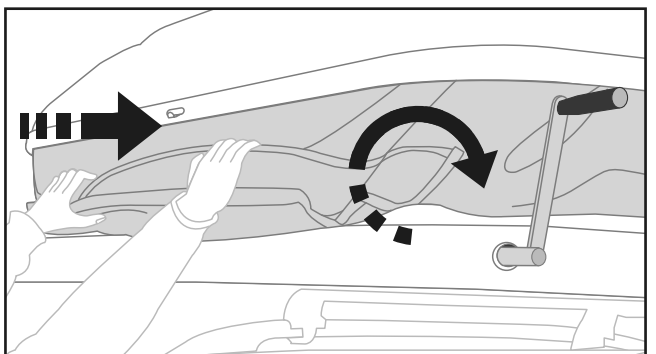
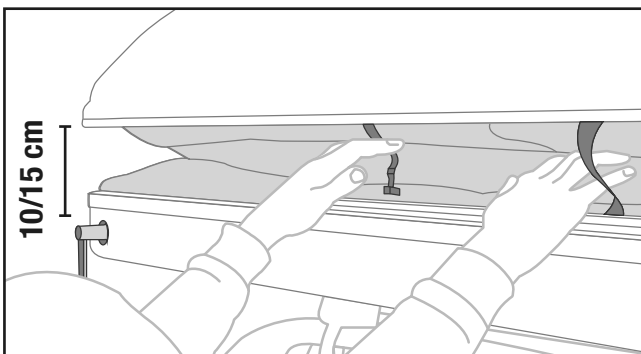

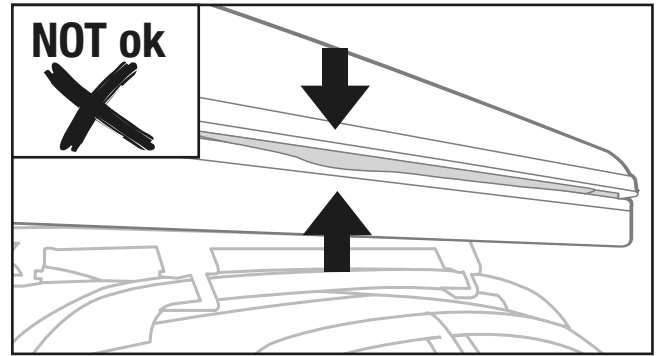
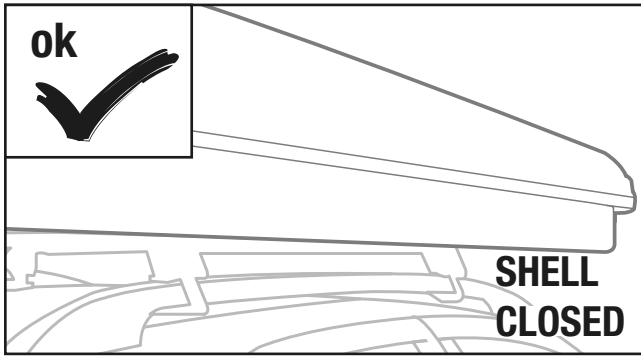
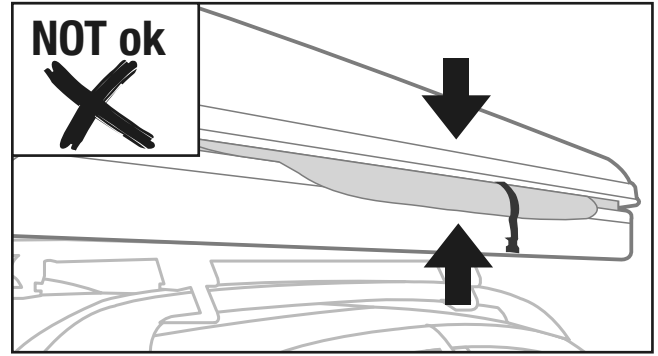
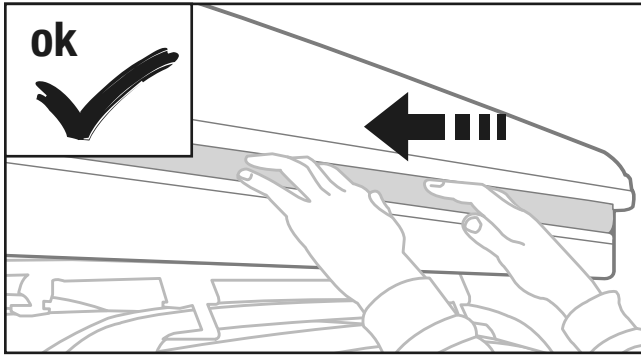

17

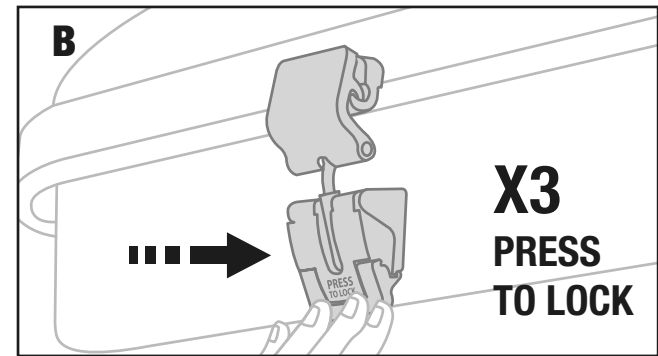
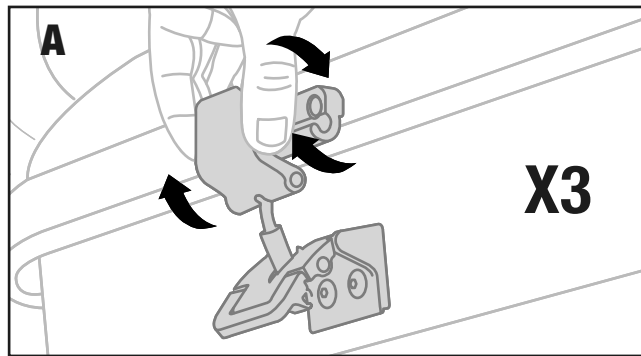

18

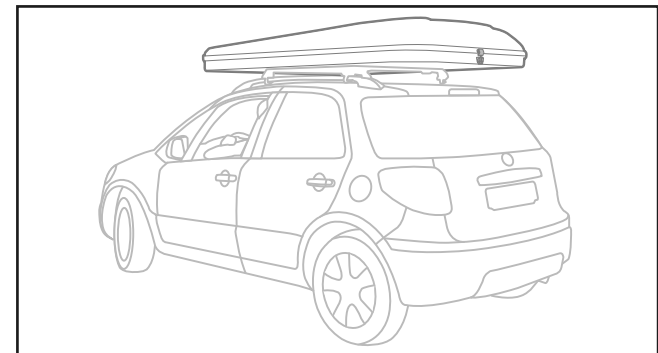
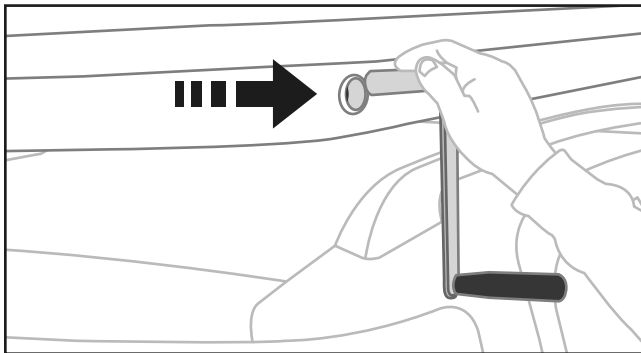

LAMP

Lampada • Lampe • Lampe

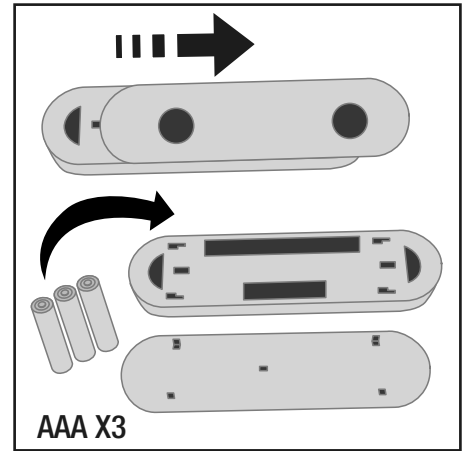
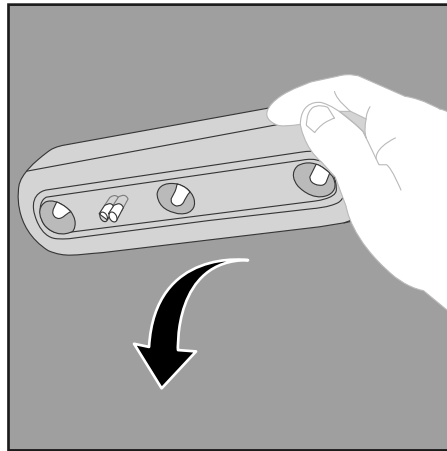
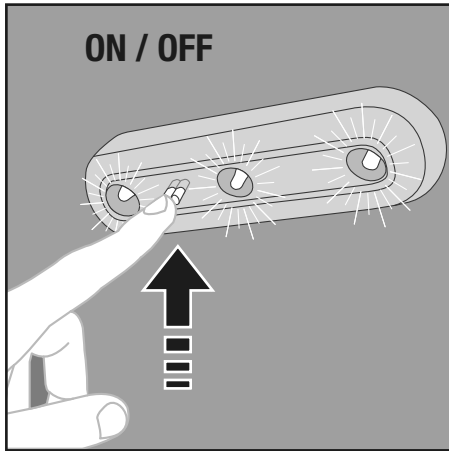

HANDLE WITH CARE

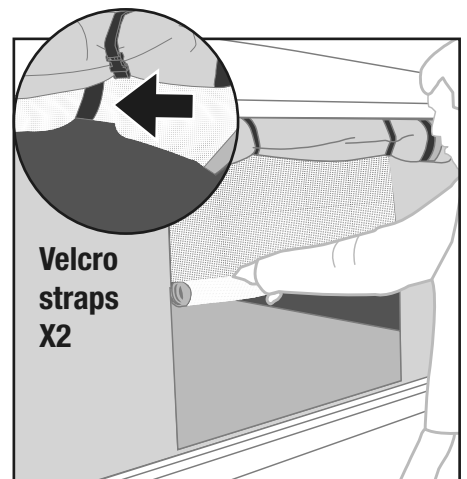
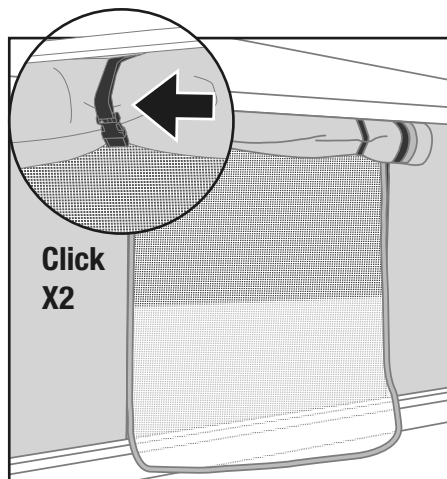
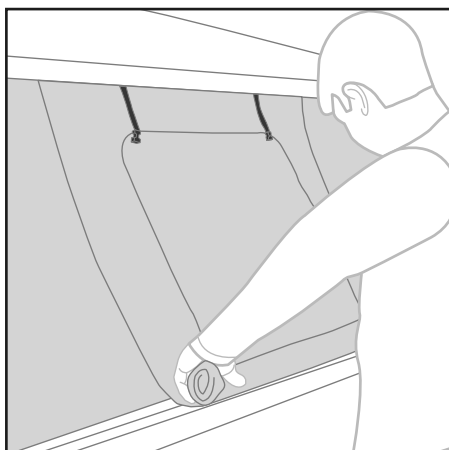
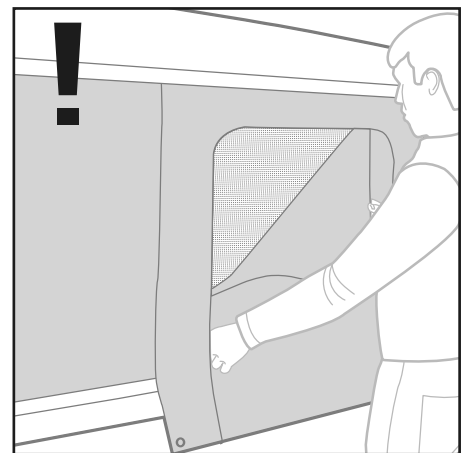
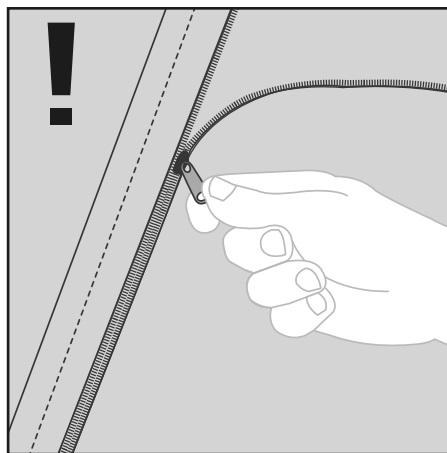
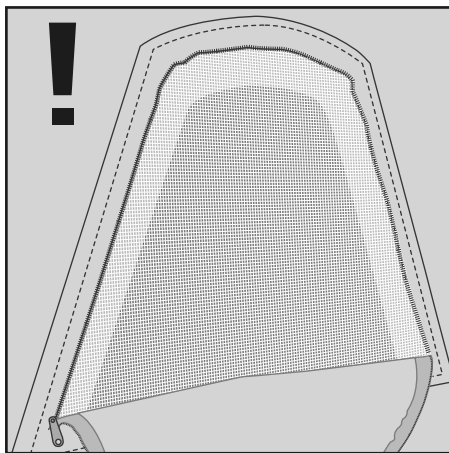

WARNINGS

Avvertenze • Avertissement • Warnungen

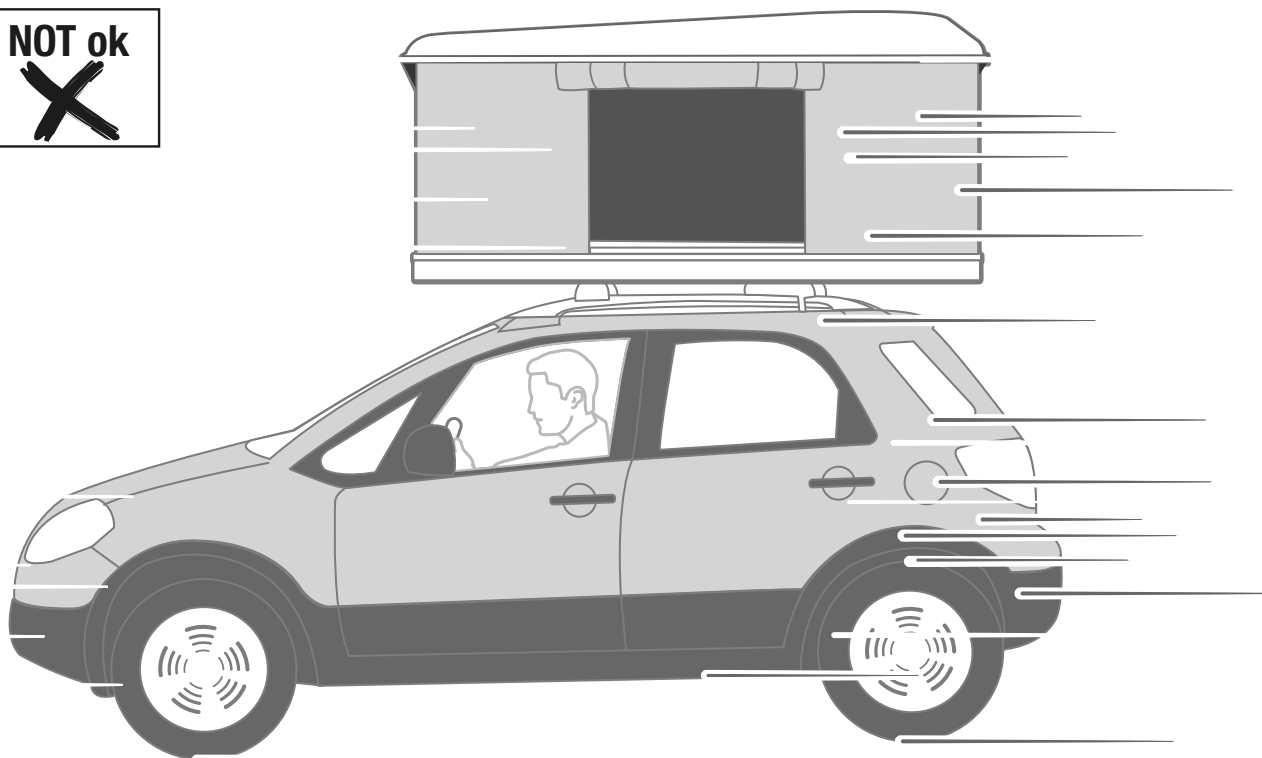
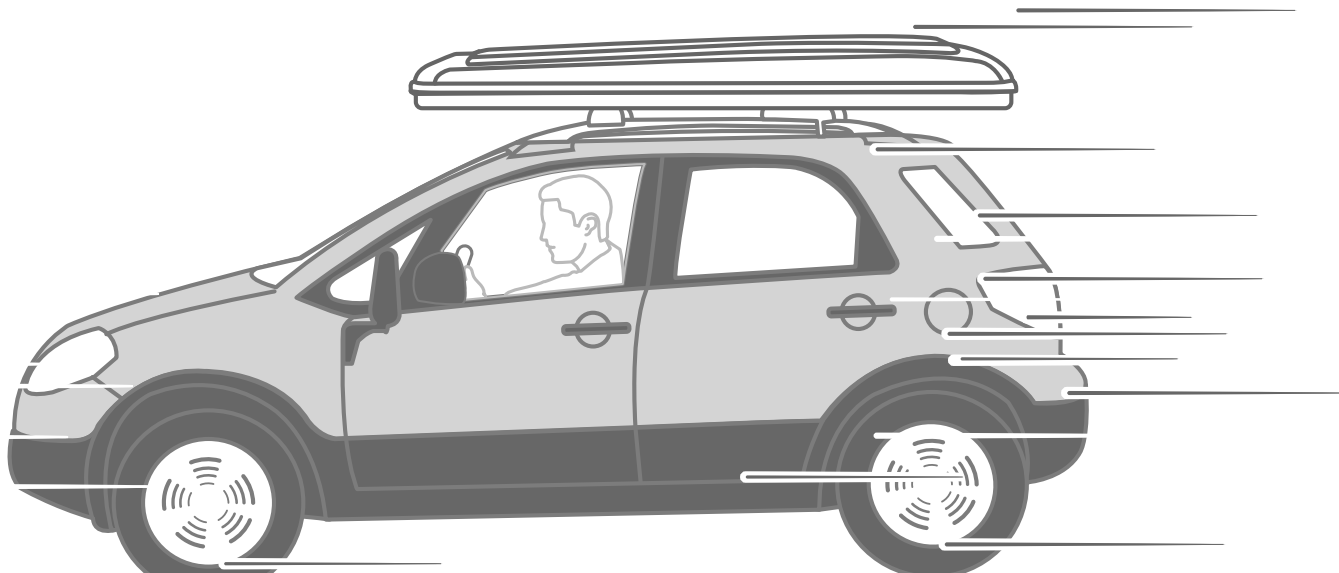

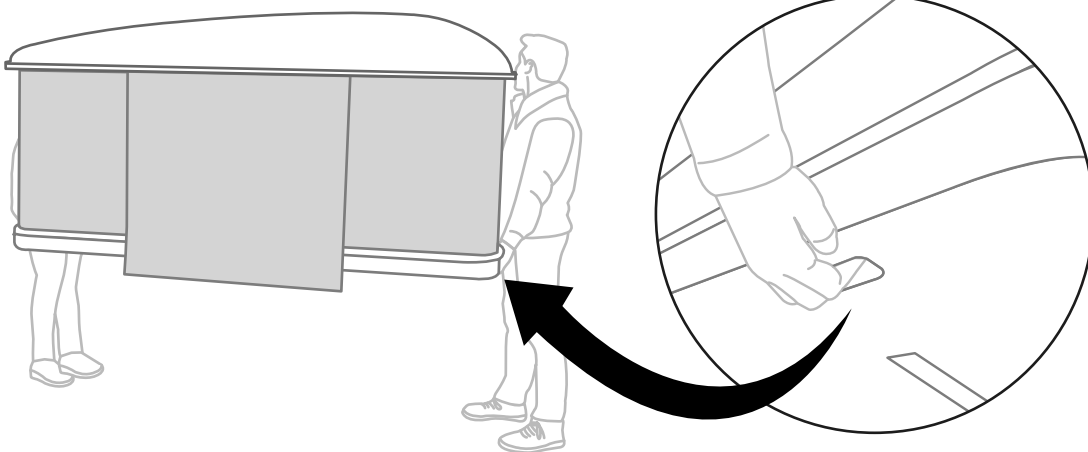
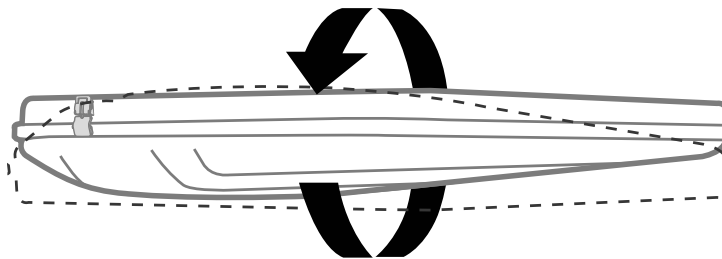
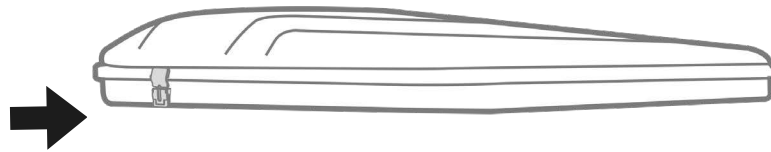
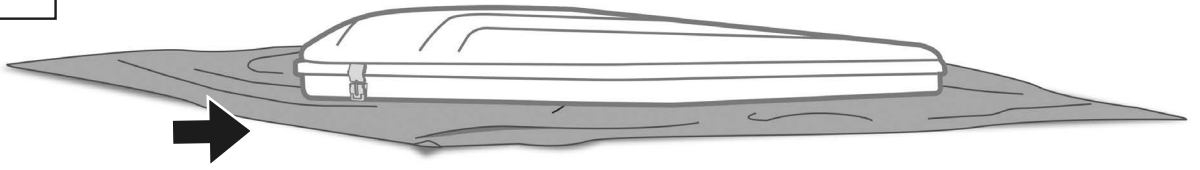

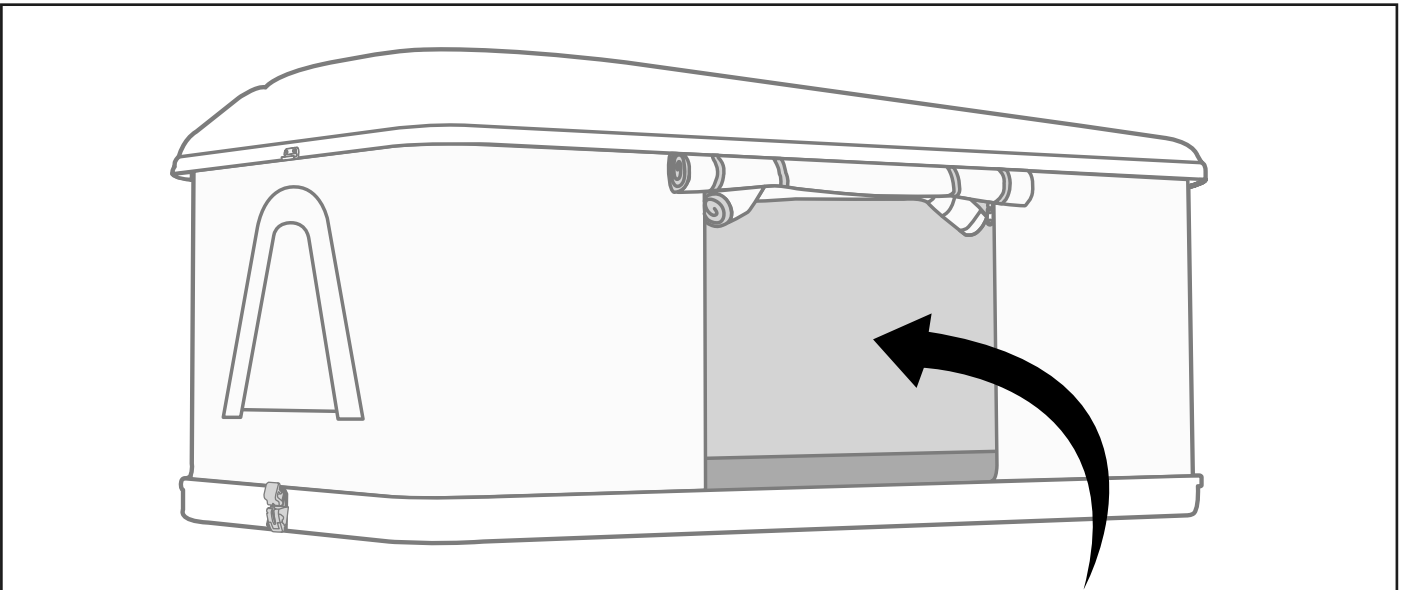
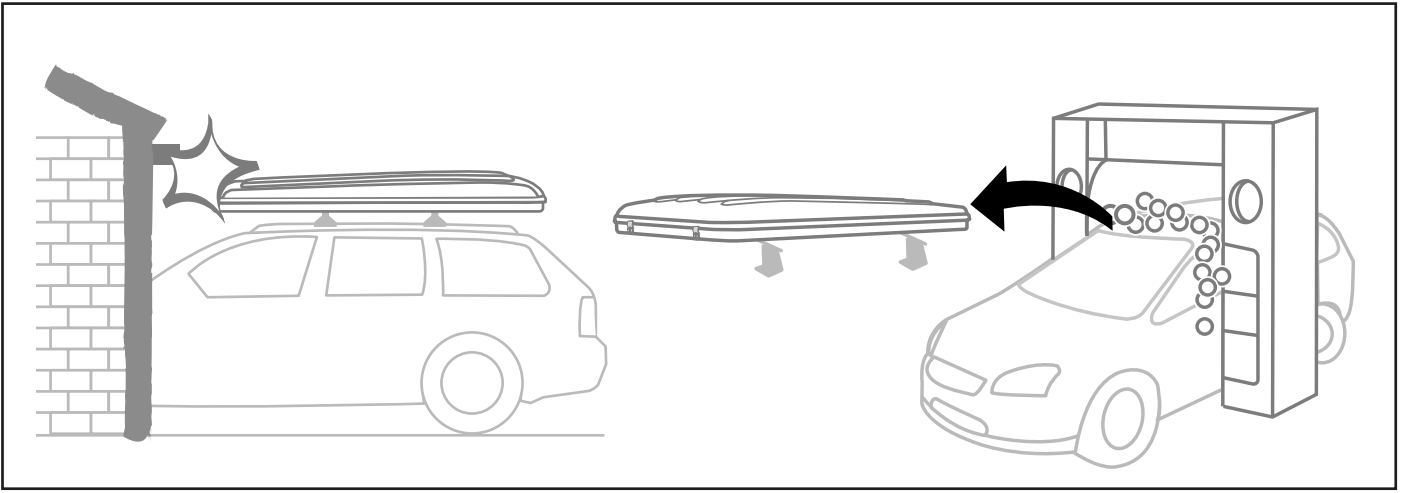





AUTOHOME® produced by
Zifer Italia Srl
Viale Risorgimento, 23
46017 Rivarolo Mantovano
(Mantova) Italy
Tel. +39 0376 99590
+39 0376 958164
Fax +39 0376 958088

AUTOHOME-OFFICIAL.COM
info@autohome.it

 MADE IN ITALY

 Autohome Official-Page

 autohome_official



PRODUCT QUALITY CERTIFICATION